

**Southwest Power Pool, Inc.
Model Development Working Group
Conference Call**

September 6th: 9:00 A.M. – 12:00 P.M. (CDT)

• M I N U T E S •

Agenda Item 1 – Administrative Items:

– Agenda Item 1a and 1b – Call to Order & Antitrust Statement:

Sunny Raheem mentioned that Nate Morris (Chairman) and Derek Brown (Vice-Chairman) will not be available for the first hour of the meeting. The Chairman has appointed Scott Schichtl as Proxy Chairman for the first hour of the meeting.

The meeting was called to order at approximately 9:02 a.m. on September 6th. The SPP Antitrust statement was read to the group at the start of the meeting on September 6th.

– Agenda Item 1c and 1d – Attendance and Proxies:

The following MDWG members and guests attended.

MDWG Members present:

MDWG Member	Present	Proxy	Present	Company
Nate Morris	YES	Jeff Crites	YES	Empire District Electric Company
Derek Brown	YES	Marcus Moor	YES	Evergy Companies
Dustin Betz	YES			Nebraska Public Power District
John Boshears	YES			City Utilities of Springfield
Jerad Ethridge	YES			Oklahoma Gas & Electric
Joe Fultz	NO	Dona Parks	YES	Grand River Dam Authority
Wayne Haidle	YES	Preston Blinsky	YES	Basin Electric Power Cooperative
Holli Krizek	YES			Western Area Power Administration
Reené Miranda	YES			Southwestern Public Service
Alex Mucha	YES			Oklahoma Municipal Power Authority
Gimod Olapurayil	YES			ITC Great Plains
Scott Schichtl	YES			Arkansas Electric Cooperative Company
Jason Shook	YES			GDS Associates
Liam Stringham	NO	Tanner New	YES	Sunflower Electric Power Corporation
Sunny Raheem	YES			Southwest Power Pool, Inc.

Antitrust: SPP strictly prohibits use of participation in SPP activities as a forum for engaging in practices or communications that violate the antitrust laws. Please avoid discussion of topics or behavior that would result in anti-competitive behavior, including but not limited to, agreements between or among competitors regarding prices, bid and offer practices, availability of service, product design, terms of sale, division of markets, allocation of customers or any other activity that might unreasonably restrain competition.

Additional Guests present:

In addition to WebEx attendance

Guests	Company
Martin Green, Nicholas Ritchie, Raghed Eleshly	American Electric Power
Josh Hesselbein	Arkansas Electric Cooperative Company
David Vernier	Associated Electric Cooperative Inc.
Preston Blinsky, Ryan Koch	Basin Electric Power Cooperative
Jerry Bradshaw, Kevin Foflygen, Kyle Anderson	City Utilities of Springfield
Tyler Baxter	Corn Belt Electric Power Cooperative
Jeff Crites	Empire District Electric Company
Cristina Ortiz, Lafayette Gatewood IV, Jeremy Harris, Ryan Baysinger, Marcus Moor Pallab Datta	Evergy Companies
Diego Toledo, Dona Parks	Grand River Dam Authority
Charles Aleman, Mark Reinart	Golden Spread Electric Cooperative
Mitch Krysa	Independence Power & Light
Charles Shue	ITC Great Plains
James Ging	Kansas Power Pool
John Payne	Kansas Electric Power Cooperative
Alan Burbach	Lincoln Electric System
Andy Berg, John Weber	Missouri River Energy Services
Armin Sehic, Bruce Doll	Municipal Energy Agency of Nebraska
Mark Mallard	Northwestern
Daryl Huslig, James Thomas	Oklahoma Electric and Gas Company
Hagen Boehmer, Hugh Benfer, Jeff McDiarmid, Michael Odom, Moses Rotich, Theva Coleman	Southwest Power Pool, Inc.
Dave Sargent, Scott Mijin	Southwestern Power Administration
Aravind Chellappa, Frank Favela	Southwestern Public Service
Tanner New	Sunflower Electric Power Cooperative
Chris Gilden	Tri-State Generation & Transmission
Chris Colson, Garrick Nelson, Josie Daggett	Western Area Power Administration
Joe Williams	Western Farmers Electric Cooperative

Antitrust: SPP strictly prohibits use of participation in SPP activities as a forum for engaging in practices or communications that violate the antitrust laws. Please avoid discussion of topics or behavior that would result in anti-competitive behavior, including but not limited to, agreements between or among competitors regarding prices, bid and offer practices, availability of service, product design, terms of sale, division of markets, allocation of customers or any other activity that might unreasonably restrain competition.

– **Agenda Item 1e(i) – Agenda Review (Action Item):**

Proxy Chairman, Scott Schichtl, asked the group if they had any modifications to the agenda or issues with the posted material. The group did not voice any modifications.

Scott opened the floor to entertain a motion.

Motion: Jason Shook motioned to approve the agenda as presented during the meeting (SEP6_MM_Attach 1 - 1e. MDWG Meeting Agenda 20180906.docx). Dustin Betz seconded the motion. The motion passed unanimously.

– **Agenda Item 1f(i) – August 2nd, 2018 Meeting Minutes Review:**

Scott Schichtl and Sunny Raheem presented the August 2nd meeting minutes. The group discussed the meeting minutes. The group did not voice any modifications.

Scott opened the floor to entertain a motion.

Motion: Dustin Betz motioned to approve the August 2nd, 2018 meeting minutes as presented at the meeting (SEP6_MM_Attach 3 - 1f. MDWG Minutes August 2, 2018.PDF). Alex Mucha seconded the motion. The motion passed unanimously.

– **Agenda Item 1g – Action Items Review:**

Sunny Raheem presented an overview of the current action items and status. Sunny gave an update for action item #22, model reduction and year 1 review. Sunny mentioned that staff would send out a survey for external model needs. Sunny asked the group if anyone had questions about a particular action item or status. The group did not voice any questions.

Antitrust: SPP strictly prohibits use of participation in SPP activities as a forum for engaging in practices or communications that violate the antitrust laws. Please avoid discussion of topics or behavior that would result in anti-competitive behavior, including but not limited to, agreements between or among competitors regarding prices, bid and offer practices, availability of service, product design, terms of sale, division of markets, allocation of customers or any other activity that might unreasonably restrain competition.

Agenda Item 2 – MDWG Manual:

- Agenda Item 2a – Language Approval (Approval Item):

Michael Odom led the discussion for the MDWG Manual language approval. Michael presented the changes to the Revision History and Section 1: Introduction. Marcus Moor, Reené Miranda, and Michael Odom provided their thoughts on the need for the new language in Section 1. They communicated the importance of clearly stating the primary deliverable for the SPP MDWG models.

Scott opened the floor to entertain a motion.

Motion: Jason Shook motioned to approve the Section 1 changes contained within the procedure manual as posted and presented (SEP6_MM_Attach 3 - 2. SPP Model Development Procedure Manual 2018 v1.2_Pending_09062018.docx). John Boshears seconded the motion. The motion passed unanimously.

Michael mentioned the MDWG Manual was updated for wholesale changes for replacing the workbook references to EDST.

Nate Morris joined the conference call and resumed Chair responsibilities from Scott Schichtl. Nate thanked Scott for facilitating and chairing the meeting in his absence. The group discussed agenda item 2b prior to the remaining items under agenda item 2a.

Michael presented the updated language for the MDWG renewable dispatch methodology. Michael communicated the need for the new language due to the current state of flux for the renewable dispatch methodology. Moses Rotich asked the group for guidance on renewable dispatch methodology for the current model build.

Nate mentioned some of the percentage values in the in the renewable dispatch methodology proposed language could be viewed as questionable. Michael explained the reasoning behind the varying percentage numbers.

Moses asked if the group would like to consider the last bullet point item for this year's model build. Nate asked the group on their thoughts on the language for the current year's model build. The group communicated their thoughts. Sunny Raheem suggested taking a break so Staff could redline the language based on the group feedback. Nate agreed to the break suggestions and requested the group be back in 10 minutes. Staff and Chris Colson redlined the language and presented it after the break. The group did not voice any concerns over the proposed redline language.

Nate opened the floor to entertain a motion.

Motion: Reené Miranda motioned to approve the renewable dispatch language within the procedure manual as presented to suffice for this model build (2019 MDWG) and requested the MDWG Manual Task Force review the language for future model builds (SEP6_MM_Attach 3 - 2. SPP Model Development Procedure Manual 2018 v1.2_Pending_09062018.docx). Holli Krizek seconded the motion. The motion passed unanimously.

Antitrust: SPP strictly prohibits use of participation in SPP activities as a forum for engaging in practices or communications that violate the antitrust laws. Please avoid discussion of topics or behavior that would result in anti-competitive behavior, including but not limited to, agreements between or among competitors regarding prices, bid and offer practices, availability of service, product design, terms of sale, division of markets, allocation of customers or any other activity that might unreasonably restrain competition.

- Agenda Item 2b – MOD 26 & 27 / Acceptable Model Discussion:

Michael presented the language proposed under the Dynamic Data Format Section of the MDWG Manual. Michael mentioned that the user models do increase troubleshooting time and sometimes have missing information. The group provided their thoughts about the effort for standard models. Marcus Moor provided his thoughts and proposed language changes. The group discussed the proposed language. The group discussed adding requirements to the SPP Generator Interconnection Agreement (GIA).

Andy Berg asked if the Generator Owner (GO) will have to redo MOD 26 & 27 standard testing or if they will be required to verify that the standard model response is acceptable in comparison to the existing MOD 26 & 27 verification testing. The group discussed the MOD 26 & 27 verification questions proposed and if language will be required. The group asked if the language would apply to Bulk Electric System (BES) generators or non-BES generators. The group requested staff to take the following action items for next steps in the standard model effort.

AL: Take updated Dynamic Data Format Section language back to the MDWG Manual Task Force for additional discussion. MDWG Manual Task Force should discuss the need for clarification applicability to non-BES and BES facilities in this section. Task Force should consider discussing a retroactive timeframe for existing facilities.

AL: Staff to coordinate with SPP GI for feedback on including standard library models language in the GIA.

Antitrust: SPP strictly prohibits use of participation in SPP activities as a forum for engaging in practices or communications that violate the antitrust laws. Please avoid discussion of topics or behavior that would result in anti-competitive behavior, including but not limited to, agreements between or among competitors regarding prices, bid and offer practices, availability of service, product design, terms of sale, division of markets, allocation of customers or any other activity that might unreasonably restrain competition.

Agenda Item 3 – Power Flow, Dynamics, Short Circuit Focus Group Discussion:

Sunny Raheem presented the scope and structure of the focus groups. Sunny re-iterated the benefit of the focus groups to the group. Sunny asked the group if they had any questions about the scope and structure as presented. The group did not voice any concerns.

Nate and Sunny thanked participants and leaders for volunteering. Dustin Betz communicated he is interested in joining a focus group and others at NPPD might be interested in them as well. Nate suggested to Dustin to send Sunny a note about the joining the focus groups.

Sunny mentioned the goal is to kick off the focus groups in October. Sunny will coordinate with the Leaders of the groups and then reach out to the participants.

Agenda Item 4 – Break:

The group took their break during the discussion of Agenda Item 2a renewable dispatch.

Agenda Item 5 – MDWG Charter Revisions:

Nate Morris led the discussion for the MDWG Charter revisions and framework document. Sunny presented the redline document received so far with the groups' changes. The group discussed the redline changes in particular the probationary timeframe requirements, transfer of voting rights, make of a balanced representation, and number of voting members. Sunny mentioned the feedback from SPP management for a balanced group representation. The group discussed the balance and number of voting members at great length.

Agenda Item 6 – 2018 MDWG Dynamics Model Build Update:

Tabled for future meeting

Agenda Item 7 – 2019 MDWG Build:

- Agenda Item 7a – Power Flow Build Update:

Tabled for future meeting

- Agenda Item 7b – Dynamics Model Schedule (Approval Item):

Tabled for future meeting

Agenda Item 8 – Future Modeling Approach:

- Agenda Item 8a – MDWG Dispatch by SPP:

Tabled for future meeting

Agenda Item 9 – 2020 ITP Generation and Load Review:

Tabled for future meeting

Agenda Item 10 – Administrative Items:

- Agenda Item 10a – Summary of Action Items:

- Take updated Dynamic Data Format Section language back to the MDWG Manual Task Force for additional discussion
- Staff to coordinate with SPP GI for feedback on including standard library models language in the GIA.

Antitrust: SPP strictly prohibits use of participation in SPP activities as a forum for engaging in practices or communications that violate the antitrust laws. Please avoid discussion of topics or behavior that would result in anti-competitive behavior, including but not limited to, agreements between or among competitors regarding prices, bid and offer practices, availability of service, product design, terms of sale, division of markets, allocation of customers or any other activity that might unreasonably restrain competition.

- Agenda Item 10b – Future Meetings:

Nate Morris provided a recap of the upcoming future meetings.

- Agenda Item 10c – Adjourn Meeting:

With no further discussion, Nate Morris solicited a motion to adjourn the meeting and table the remaining items.

Motion: Jerad Ethridge motioned to adjourn the meeting and table the remaining items. Jason Shook seconded it. The motion passed unanimously.

The meeting adjourned at 12:27PM (CDT).

Respectfully submitted,
Sunny Raheem
SPP Staff Secretary



Southwest Power Pool, Inc.
MODEL DEVELOPMENT WORKING GROUP

September 6, 2018

Net Conference

• A G E N D A •

9:00 a.m. – 12:00 p.m. (CDT)

1. Administrative Items Nate Morris (10 mins)
 - a. Call to Order
 - b. Antitrust Statement
 - c. Attendance
 - d. Proxies
 - e. Agenda Review (**Approval Item**)
 - i. Acknowledgement of discuss meeting materials
 - f. Previous Meeting Minutes
 - i. August 2nd, 2018 (**Approval Item**)
 - g. Action Items Review
2. MDWG Manual
 - a. Language Approval (**Approval Item***)Michael Odom (25 mins)
 - b. MOD 26 & 27 / Acceptable Model Discussion..... All (20 mins)
3. Power Flow, Dynamics, Short Circuit Focus Group Discussion All (30 mins)
4. Break (10 mins)
5. MDWG Charter Revision All (20 mins)
6. 2018 MDWG Dynamics Model Build Update Sunny Raheem (5 mins)
7. 2019 MDWG Build
 - a. Power Flow Build Update Moses Rotich (5 mins)
 - b. Dynamics Model Schedule (**Approval Item***)..... Sunny Raheem (20 mins)
8. Future Modeling Approach
 - a. MDWG Dispatch by SPP All (15 mins)
9. 2020 ITP Generation and Load Review Theva Coleman (10 mins)
10. Administrative Items Nate Morris (10 mins)
 - a. Summary of Action Items
 - b. Future Meetings
 - i. October 4th
 - c. Adjourn

Note: The approval items denoted with “*” shall be jointly developed by PC, TP, and MDWG.

Antitrust: SPP strictly prohibits use of participation in SPP activities as a forum for engaging in practices or communications that violate the antitrust laws. Please avoid discussion of topics or behavior that would result in anti-competitive behavior, including but not limited to, agreements between or among competitors regarding prices, bid and offer practices, availability of service, product design, terms of sale, division of markets, allocation of customers or any other activity that might unreasonably restrain competition.

**Southwest Power Pool, Inc.
Model Development Working Group
Conference Call**

August 2nd: 10:00 A.M. – 1200 P.M. (CDT)

• M I N U T E S •

Agenda Item 1 – Administrative Items:

– Agenda Item 1a and 1b – Call to Order & Antitrust Statement:

The meeting was called to order at approximately 10:01 a.m. on August 2nd. The SPP Antitrust statement was read to the group at the start of the meeting on August 2nd.

– Agenda Item 1c and 1d – Attendance and Proxies:

The following MDWG members and guests attended.

MDWG Members present:

MDWG Member	Present	Proxy	Present	Company
Nate Morris	YES			Empire District Electric Company
Derek Brown	YES			Evergy Companies
Dustin Betz	YES			Nebraska Public Power District
John Boshears	YES			City Utilities of Springfield
Jerad Ethridge	YES			Oklahoma Gas & Electric
Joe Fultz	YES			Grand River Dam Authority
Wayne Haidle	YES			Basin Electric Power Cooperative
Holli Krizek	NO	Chris Colson	YES	Western Area Power Administration
Reené Miranda	YES			Southwestern Public Service
Alex Mucha	YES			Oklahoma Municipal Power Authority
Gimod Olapurayil	YES			ITC Great Plains
Scott Schichtl	YES			Arkansas Electric Cooperative Company
Jason Shook	YES			GDS Associates
Liam Stringham	NO	Tanner New	YES	Sunflower Electric Power Corporation
Sunny Raheem	YES			Southwest Power Pool, Inc.

Antitrust: SPP strictly prohibits use of participation in SPP activities as a forum for engaging in practices or communications that violate the antitrust laws. Please avoid discussion of topics or behavior that would result in anti-competitive behavior, including but not limited to, agreements between or among competitors regarding prices, bid and offer practices, availability of service, product design, terms of sale, division of markets, allocation of customers or any other activity that might unreasonably restrain competition.

Additional Guests present:

In addition to WebEx attendance

Guests	Company
Martin Green	American Electric Power
David Vernier	Associated Electric Cooperative Inc.
Ryan Koch	Basin Electric Power Cooperative
Jerry Bradshaw, Kevin Foflygen	City Utilities of Springfield
Lafayette Gatewood IV, Jeremy Harris Ryan Baysinger, Marcus Moor	Evergy Companies
Charles Aleman	Golden Spread Electric Cooperative
Mitch Krysa	Independence Power & Light
Charles Shue, Matthew Keenan	ITC Great Plains
James Ging	Kansas Power Pool
Alan Burbach	Lincoln Electric System
Andy Berg, John Weber	Missouri River Energy Services
Armin Sehic, Bruce Doll	Municipal Energy Agency of Nebraska
Mark Mallard	Northwestern
Jason Lawter	Oklahoma Corporation Commission
Daryl Huslig	Oklahoma Electric and Gas Company
John Mayhan	Omaha Public Power District
Eddie Watson, Kim Farris, Moses Rotich	Southwest Power Pool, Inc.
Dave Sargent, Scott Mijin	Southwestern Power Administration
Aravind Chellappa, Frank Favela	Southwestern Public Service
Tanner New	Sunflower Electric Power Cooperative
Brianna Haug, Chris Colson, Garrick Nelson, Josie Daggett	Western Area Power Administration

Antitrust: SPP strictly prohibits use of participation in SPP activities as a forum for engaging in practices or communications that violate the antitrust laws. Please avoid discussion of topics or behavior that would result in anti-competitive behavior, including but not limited to, agreements between or among competitors regarding prices, bid and offer practices, availability of service, product design, terms of sale, division of markets, allocation of customers or any other activity that might unreasonably restrain competition.

– Agenda Item 1e(i) – Agenda Review (Action Item):

Nate Morris asked the group if they had any modifications to the agenda or issues with the posted material. The group did not voice any modifications.

Nate opened the floor to entertain a motion.

Motion: Chris Colson motioned to approve the agenda as presented during the meeting (AUG2_MM_Attach 1 - 1e. MDWG Meeting Agenda 20180802.docx). Scott Schichtl seconded the motion. The motion passed unanimously.

– Agenda Item 1f(i) – July 12th, 2018 Meeting Minutes Review (Action Item):

Nate Morris and Sunny Raheem presented the July 12th meeting minutes. The group discussed the meeting minutes. Nate mentioned the recommendation by a group member to post the previous meeting minutes and supplemental data in one file. Staff will attempt to post meeting material and support files as one file in the subsequent meeting background material.

Nate opened the floor to entertain a motion.

Motion: John Boshears motioned to approve the July 12th, 2018 meeting minutes as presented at the meeting (AUG2_MM_Attach 2 - 1f. MDWG Minutes July 12, 2018_redline.docx). Derek Brown seconded the motion. The motion passed with one abstention. Reené Miranda mentioned that he abstained because he was not present at the July 12th meeting.

– Agenda Item 1q – Action Items Review:

Sunny Raheem presented an overview of the current action items and status. Sunny asked the group if anyone had questions about a particular action item or status. The group did not voice any questions.

Antitrust: SPP strictly prohibits use of participation in SPP activities as a forum for engaging in practices or communications that violate the antitrust laws. Please avoid discussion of topics or behavior that would result in anti-competitive behavior, including but not limited to, agreements between or among competitors regarding prices, bid and offer practices, availability of service, product design, terms of sale, division of markets, allocation of customers or any other activity that might unreasonably restrain competition.

Agenda Item 2 – MDWG Manual:

- Agenda Item 2a – SPP Legal Model Release Language Addition:

Sunny Raheem presented the SPP Legal requested Model Release Language addition and removal of outdated language. Sunny mentioned the new language aligns with the model release language on the SPP corporate website. The group did not voice any concerns or questions about the model release language.

- Agenda Item 2b – Language Approval (Approval Item):

Nate Morris led the group in the language approval discussion. Chris Colson asked Nate if he would be open to entertaining a motion.

Nate opened the floor to entertain a motion.

Motion: Chris Colson motioned to approve all changes contained within the procedure manual posted and presented (AUG2_MM_Attach 3 - 2. SPP Model Development Procedure Manual 2018 v1_pending updates_Revised_12JUL18.docx). Alex Mucha seconded the motion.

During the discussion of the motion, Reené Miranda requested a quick glance through the changes for the group to review. The group discussed dispatching renewables with firm and non-firm service. The group compared the proposed MDWG language against the ITP language. The group discussed concerns related to stability issues because of the new wind and solar generation amounts. The group discussed how replacement data is incorporated in calculation when required. The group asked staff if the renewable dispatch would be available for the current 2019 MDWG build. Moses Rotich responded that SPP would provide the dispatch in spreadsheet format. Replacement data will be used for wind farms that do not have any historical data or have only a few years of historical data.

The motion passed with one abstention. Dustin Betz mentioned he abstained because he was not available to join the call for the full discussion.

Chris Colson and the group thanked Michael Odom for his efforts in reformatting the manual and for keeping the task force on track.

Antitrust: SPP strictly prohibits use of participation in SPP activities as a forum for engaging in practices or communications that violate the antitrust laws. Please avoid discussion of topics or behavior that would result in anti-competitive behavior, including but not limited to, agreements between or among competitors regarding prices, bid and offer practices, availability of service, product design, terms of sale, division of markets, allocation of customers or any other activity that might unreasonably restrain competition.

- Agenda Item 2c – Power Flow, Dynamics, Short Circuit Task Force Discussion:

Nate Morris led the group in the three task force discussion. Nate mentioned his thoughts on the structure of the focus groups, participation, and deliverables. Sunny Raheem mentioned staff's suggestions on keeping the groups informal at least to start with. Sunny mentioned that staff would be assigned to help support the focus groups. Sunny mentioned that he thinks the benefit will be mutual for members and staff for educational purposes. Eddie Watson mentioned that he would like the focus groups to be an avenue for both staff and members to learn from each other.

Chris Colson expressed strong support for this effort. Chris stated WAPA expressed the need to form these three groups as part of the MDWG charter. Chris mentioned that the focus groups should not be composed of only model builders but should also include end users of the models who can discuss some of the issues that they are seeing.

As next steps, Sunny recommended that entities volunteer for these different groups ahead of the September meeting. Nate also commented that Data Submitters who are not familiar with certain aspects such as dynamics should get involved in them to learn.

Action Item: Staff to poll conference call participants and MDWG exploder email lists for volunteers.

Agenda Item 3 – MDWG Charter Revisions:

Nate Morris led the group in the MDWG Charter Revision discussion. Nate asked Sunny Raheem to present the draft provided to staff. Sunny presented the draft revisions. Sunny mentioned staff will have a preliminary review of proposed language before the September meeting.

Jason Shook disagreed with some of the proposed language. Jason mentioned that membership should be open to any SPP member regardless of registration. Jason did not think it is appropriate to limit SPP members. Jason mentioned entities such as GOs, DPs, and any entity with vested interest in the models should have a stake in the models.

Nate answered that every entity can still contribute to the group without being a voting member. Jason responded that this criteria can apply to Transmission Planning entities also; Transmission Planners can actively participate without being members. Dustin Betz stated he liked the idea of expanding to accommodate other members but had concerns about the prescriptive nature of the language.

Action Item: Staff to send the proposed language along with the current MDWG charter to Data Submitters for comments on membership guidelines in the charter revision.

Antitrust: SPP strictly prohibits use of participation in SPP activities as a forum for engaging in practices or communications that violate the antitrust laws. Please avoid discussion of topics or behavior that would result in anti-competitive behavior, including but not limited to, agreements between or among competitors regarding prices, bid and offer practices, availability of service, product design, terms of sale, division of markets, allocation of customers or any other activity that might unreasonably restrain competition.

Agenda Item 4 – MOD 26 & 27 Model Validation:

- Agenda Item 4a – Standard Model List:

Joe Fultz led the group in the Standard Model List discussion. Joe mentioned that SPP had sent guidelines a while back. Joe mentioned his view was that there were several ways to validate the data. Sunny Raheem provided a discussion summary that staff had with MISO and how MISO moved to a standard model list. Chris Colson suggested that some language be drafted in the manual that states that SPP adopts the NERC standard models and that Generator Owners use these models in their testing. Nate Morris agreed with Chris. Chris noted that there is a gap with GOs who do not have TPs. Reené Miranda mentioned that SPP could reach out to ERCOT to find out how their standard model list process worked. Derek Brown agreed with adopting the standard models in the manual but noted that a few exceptions may have to be made for GOs who have already provided their MOD-026 & 027 data.

Action Item: MDWG Manual Task Force to start discussing and drafting standard model approach with consideration of exceptions.

Agenda Item 5 – 2019 MDWG Power Flow Model Build Discussion:

- Agenda Item 5a – Power Flow Build Update:

Moses Rotich provided an update for the 2019 MDWG Power Flow Model build. Moses mentioned the status of the model build. Moses asked the group if they had any questions or concerns about the model build. The group did not voice concerns.

- Agenda Item 5b – Automation Improvements:

Sunny Raheem provided an overview of recent automation efforts. Sunny mentioned Zack Bearden identified a need for internal automation. This automation also meets some of the suggestions from the MDWG untimely data submission survey. Sunny asked if the group had any suggestions or comments about the automation that is under development for load pattern review. The group did not voice any questions or concerns.

Agenda Item 6 – Future Modeling Approach:
- Agenda Item 6a – ITP to MMWG Conversion:
Tabled for future meeting

- Agenda Item 6b – MDWG Models Dispatched by SPP:
Tabled for future meeting

Agenda Item 7 – 2019 MDWG Dynamics Model Draft Schedule:

Sunny Raheem presented the first draft of the 2019 MDWG dynamic model build schedule. Sunny explained the internal SPP TPL need for finalizing models in December. Sunny mentioned it would be a good time for the members to communicate their compliance year requirements since the proposed schedule has a December finalization date. Several members voiced their concerns about the December model finalization date due to their compliance year being January to December.

Agenda Item 8 – Administrative Items:

- Agenda Item 8a – Summary of Action Items:

- **Staff to poll conference call participants and MDWG exploder email lists for volunteers.**
- **Staff to send the proposed language along with the current MDWG charter to Data Submitters for comments on membership guidelines in the charter revision.**
- **MDWG Manual Task Force to start discussing and drafting standard model approach with consideration of exceptions.**

- Agenda Item 8b – Future Meetings:

Nate Morris provided a recap of the upcoming future meetings. Nate requested the September 6th meeting be 3 hours in duration to allow adequate time for tabled discussions.

- Agenda Item 8c – Adjourn Meeting:

With no further discussion, Nate Morris solicited a motion to adjourn the meeting and table the remaining items.

Motion: Chris Colson motioned to adjourn the meeting. Chris Colson seconded it. The motion passed unanimously.

The meeting adjourned at 12:15PM (CDT).

Respectfully submitted,
Sunny Raheem
SPP Staff Secretary

Southwest Power Pool, Inc.
MODEL DEVELOPMENT WORKING GROUP

August 2, 2018

Net Conference

• A G E N D A •

10:00 a.m. – 12:00 p.m. (CDT)

1. Administrative Items Nate Morris (5 mins)
 - a. Call to Order
 - b. Antitrust Statement
 - c. Attendance
 - d. Proxies
 - e. Agenda Review (**Approval Item**)
 - i. Acknowledgement of discuss meeting materials
 - f. Previous Meeting Minutes
 - i. July 12th, 2018 (**Approval Item**)
 - g. Action Items Review
2. MDWG Manual
 - a. SPP Legal Model Release Language Addition Sunny Raheem (5 mins)
 - b. Language Approval (**Approval Item***) All (15 mins)
 - c. Power Flow, Dynamics, Short Circuit Task Force Discussion All (20 mins)
3. MDWG Charter Revision All (15 mins)
4. MOD 26 & 27 Model Validation Discussion
 - a. Standard Model List..... Joe Fultz/All(15 mins)
5. 2019 MDWG Power Flow Build
 - a. Power Flow Build Update Moses Rotich/All (5 mins)
 - b. Automation Improvements Zack Bearden (5 mins)
6. Future Modeling Approach
 - a. ITP to MMWG Conversion..... All (15 mins)
 - b. MDWG Models dispatched by SPP..... All (10 mins)
7. 2019 MDWG Dynamics Model Draft Schedule All (5 mins)
8. Administrative Items Nate Morris (5 mins)
 - a. Summary of Action Items
 - b. Future Meetings
 - i. September 6th
 - c. Adjourn

Note: The approval items denoted with “*” shall be jointly developed by PC, TP, and MDWG.

Antitrust: SPP strictly prohibits use of participation in SPP activities as a forum for engaging in practices or communications that violate the antitrust laws. Please avoid discussion of topics or behavior that would result in anti-competitive behavior, including but not limited to, agreements between or among competitors regarding prices, bid and offer practices, availability of service, product design, terms of sale, division of markets, allocation of customers or any other activity that might unreasonably restrain competition.

Southwest Power Pool, Inc.
Model Development Working Group
Conference Call
July 12th: 1:00 P.M. – 3:00 P.M. (CDT)

• M I N U T E S •

Agenda Item 1 – Administrative Items:

– Agenda Item 1a and 1b – Call to Order & Antitrust Statement:

The meeting was called to order at approximately 1:00 p.m. on July 12. The SPP Antitrust statement was read to the group at the start of the meeting on July 12.

– Agenda Item 1c and 1d – Attendance and Proxies:

The following MDWG members and guests attended.

MDWG Members present:

MDWG Member	Present	Proxy	Present	Company
Nate Morris	YES			Empire District Electric Company
Derek Brown	YES			Evergy Companies
Dustin Betz	YES			Nebraska Public Power District
John Boshears	YES			City Utilities of Springfield
Jerad Ethridge	YES			Oklahoma Gas & Electric
Joe Fultz	YES			Grand River Dam Authority
Wayne Haidle	YES			Basin Electric Power Cooperative
Holli Krizek	YES			Western Area Power Administration
Reené Miranda	NO	Aravind Chellappa	YES	Southwestern Public Service
Alex Mucha	YES			Oklahoma Municipal Power Authority
Gimod Olapurayil	YES			ITC Great Plains
Scott Schichtl	NO			Arkansas Electric Cooperative Company
Jason Shook	YES			GDS Associates
Liam Stringham	YES			Sunflower Electric Power Corporation
Sunny Raheem	YES			Southwest Power Pool, Inc.

Antitrust: SPP strictly prohibits use of participation in SPP activities as a forum for engaging in practices or communications that violate the antitrust laws. Please avoid discussion of topics or behavior that would result in anti-competitive behavior, including but not limited to, agreements between or among competitors regarding prices, bid and offer practices, availability of service, product design, terms of sale, division of markets, allocation of customers or any other activity that might unreasonably restrain competition.

Additional Guests present:

In addition to WebEx attendance

Guests	Company
Martin Green, Scott Rainbolt	American Electric Power
David Vernier	Associated Electric Cooperative Inc.
Jerry Bradshaw	City Utilities of Springfield
Jordan Lamb	East River Cooperative
Sonny Patel	EDF-RE
Jeff Crites	Empire District Electric
Lafayette Gatewood IV, Jeremy Harris Ryan Baysinger, Marcus Moor, Pallab Datta	Evergy Companies
Diego Toledo, Dona Parks	Grand River Dam Authority
Charles Shue, Matthew Keenan	ITC Great Plains
Alan Burbach	Lincoln Electric System
Tom Hopkins	Midwest Energy
Andy Berg, John Weber	Missouri River Energy Services
Armin Sehic, Bruce Doll	Municipal Energy Agency of Nebraska
Mark Mallard	Northwestern
Jason Lawter	Oklahoma Corporation Commission
John Mayhan	Omaha Public Power District
Eddie Watson, Hagen Boehmer, Joseph Price, Kim Farris, Michael Odom, Moses Rotich, Sherri Maxey, Zack Bearden	Southwest Power Pool, Inc.
Christopher Diamond, Terry Crawley	Southern Company
Aravind Chellappa	Southwestern Public Service
Chris Gilden	Tri-State Generation & Transmission
Garrick Nelson, Josie Daggett	Western Area Power Administration
Calvin Daniels, Joe Williams	Western Farmers Electric Coop

Antitrust: SPP strictly prohibits use of participation in SPP activities as a forum for engaging in practices or communications that violate the antitrust laws. Please avoid discussion of topics or behavior that would result in anti-competitive behavior, including but not limited to, agreements between or among competitors regarding prices, bid and offer practices, availability of service, product design, terms of sale, division of markets, allocation of customers or any other activity that might unreasonably restrain competition.

– Agenda Item 1e(i) – Agenda Review (Action Item):

Nate Morris asked the group if they had any modifications to the agenda or issues with the posted material. Sunny Raheem mentioned that staff would like to request adding 2019 MDWG Power Flow Model Build Discussion to the agenda. The group decided to place the 2019 MDWG Power Flow Model Build Discussion as agenda item #5.

Nate opened the floor to entertain a motion.

Motion: Derek Brown motioned to approve the agenda as presented during the meeting ([Jul12 MM Attachment 1 - 1e. MDWG Meeting Agenda 20180712_redline.docx](#)). Jerad Ethridge seconded the motion. The motion passed unanimously.

– Agenda Item 1f(i) – June 28th, 2018 Meeting Minutes Review (Action Item):

Nate Morris and Sunny Raheem presented the June 28 meeting minutes with latest member provided redlines. The group discussed the meeting minutes. Aravind Chellappa mentioned he had limited time to review the background material and previous meeting minutes since he had other obligations during majority of the review period. Derek Brown requested KCPL and Westar be presented as one entity in the meeting material going forward. Sunny Raheem redlined the June 28, 2018 meeting minutes referencing Evergy for both KCPL and Westar.

Nate opened the floor to entertain a motion.

Motion: Derek Brown motioned to approve the June 28th, 2018 meeting minutes as edited and presented at the meeting ([Jul12 MM Attachment 2 - 1f. MDWG Minutes June 28, 2018_redline.docx](#)). Gimod Olapurayil seconded the motion. The motion passed with one abstention from Alex Mucha. Alex explained he is abstaining because he was not present at the last meeting.

– Agenda Item 1g – Action Items Review:

Sunny Raheem presented an overview of the current action items and status. Aravind Chellappa requested an open-ended action item be added to the list for model reduction and year 1 definition as discussed in the previous meetings.

Action Item: Staff to provide updates on the model reduction and Year 1 definition effort as they progress with the action item.

– Agenda Item 1h – Draft July 12th Agenda:

Nate Morris asked Sunny Raheem to provide the overview for the August 2nd draft agenda. Sunny presented the August 2nd draft agenda. The group did not mention any concerns or edits to the draft agenda as presented.

Agenda Item 2 – MDWG Manual:

- Agenda Item 2a – Language Approval (Approval Item):

Michael Odom presented to the group the MDWG manual changes.

In the Bus Section, the group discussed the need for adding an example, consideration of historical consistencies, bus name dependencies in other software such as ASPEN, and purpose of the bus naming conventions.

Holli Krizek mentioned the need to keep the historical consistency language for entities that previously were in the MRO since their naming convention was different. Dustin Betz also mentioned the same concerns. Staff mentioned MMWG requires unique bus names. Zack Bearden mentioned the SPP EMS modeling group uses the bus names. The group discussed setting an effective date for the possible bus naming convention requirements. Eddie Watson mentioned when SPP Operations went through a similar effort they set an effective date for all entities to meet the bus naming convention requirements.

After a lengthy discussion, the group requested the manual task force to review the Bus Section language for reconsideration of the concerns raised at the meeting.

In the Short Circuit Data Format Section, the group discussed the language additions to account for GSU modeling updates for retired generator in short circuit models. The group discussed if the GSUs should be kept online even with a disconnect switch or interruption device. The group provided edits to the manual language.

Nate opened the floor to entertain a motion.

Motion: Jerad Ethridge motioned to approve the language pertaining to pseudo tied loads and short circuit section GSUs language ([Jul12 MM Attachment 3 - 2a. SPP Model Development Procedure Manual 2018 v1_ Revised_ 12JUL18.docx](#)). Alex Mucha seconded the motion. The vote discussion lead to additional language to clarify the transformer status. Jerad Ethridge motioned to amend the open motion to account for additional transformer status language. Alex Mucha seconded the motion. The motion passed unanimously.

Antitrust: SPP strictly prohibits use of participation in SPP activities as a forum for engaging in practices or communications that violate the antitrust laws. Please avoid discussion of topics or behavior that would result in anti-competitive behavior, including but not limited to, agreements between or among competitors regarding prices, bid and offer practices, availability of service, product design, terms of sale, division of markets, allocation of customers or any other activity that might unreasonably restrain competition.

- Agenda Item 2b – Power Flow, Dynamics, Short Circuit Task Force Discussion:

Tabled for future meeting.

Agenda Item 3 – MDWG Charter Membership Revisions:

Tabled for future meeting.

Agenda Item 4 – 2018 MDWG Dynamics Model Build Update:

Michael Odom provided an update on the schedule. Michael reviewed the most recent 2018 Dynamics Model Build schedule. Michael mentioned a consultant has been hired to help mitigate the schedule delay.

Agenda Item 5 – 2019 MDWG Power Flow Model Build Discussion:

Moses Rotich provided an update for the 2019 MDWG Power Flow Model build. Moses mentioned he would create two sets of device control profiles for ITP and MDWG based on member feedback from the previous model build. Moses asked the group if that approach was still the preference. The group agreed to this approach.

To make the members aware, Moses also commented that going forward, the ITP BR models which will be used for TPL and other compliance studies, will be finalized late November/December annually. He noted that members who rely on these models to perform their TPL assessments might want to do a transition in order to align with the release of the models.

Sunny Raheem mentioned resource changes in the modeling group. Sunny mentioned Mitch Jackson accepted a position in Engineering Support and Hagen Boehmer joined the modeling group. Nate Morris asked when the resource changes were effective. Eddie Watson mentioned they are already effective. The group welcome Hagen and thanked Mitch for his service to the group, model builds, and EDST.

Agenda Item 6 – MOD 26 & 27 Model Validation Discussion:

- Agenda Item 6a – Standard Model List:

Tabled for future meeting

Agenda Item 7 – Engineering Data Submission Tool (EDST):

- Agenda Item 7a – Status Update:

- Agenda Item 7b – Prioritizing Project Enhancements:

Tabled for future meeting

Agenda Item 8 – Administrative Items:

- Agenda Item 8a – Summary of Action Items:

- **Model reduction and Year 1 definition effort action item updates**

- Agenda Item 8b – Future Meetings:

Nate Morris provided a recap of the upcoming future meetings. Nate mentioned the upcoming MOD training on July 26th and the next MDWG meeting on August 2nd.

Antitrust: SPP strictly prohibits use of participation in SPP activities as a forum for engaging in practices or communications that violate the antitrust laws. Please avoid discussion of topics or behavior that would result in anti-competitive behavior, including but not limited to, agreements between or among competitors regarding prices, bid and offer practices, availability of service, product design, terms of sale, division of markets, allocation of customers or any other activity that might unreasonably restrain competition.

- Agenda Item 8c – Adjourn Meeting:

With no further discussion, Nate Morris solicited a motion to adjourn the meeting and table the remaining items.

Motion: Joe Fultz motioned to adjourn the meeting and table the remaining items. Jerad Ethridge seconded it. The motion passed unanimously.

The meeting adjourned at 3:06PM (CDT).

Respectfully submitted,
Sunny Raheem
SPP Staff Secretary



**MODEL DEVELOPMENT
PROCEDURE MANUAL**
Model Development Working Group

June 2018

MODEL DEVELOPMENT WORKING GROUP

Southwest Power Pool, Inc.

REVISION HISTORY

DATE OR VERSION NUMBER	AUTHOR	CHANGE DESCRIPTION	COMMENTS
21JUN18	SPP Engineering Modeling	Updated format	

|

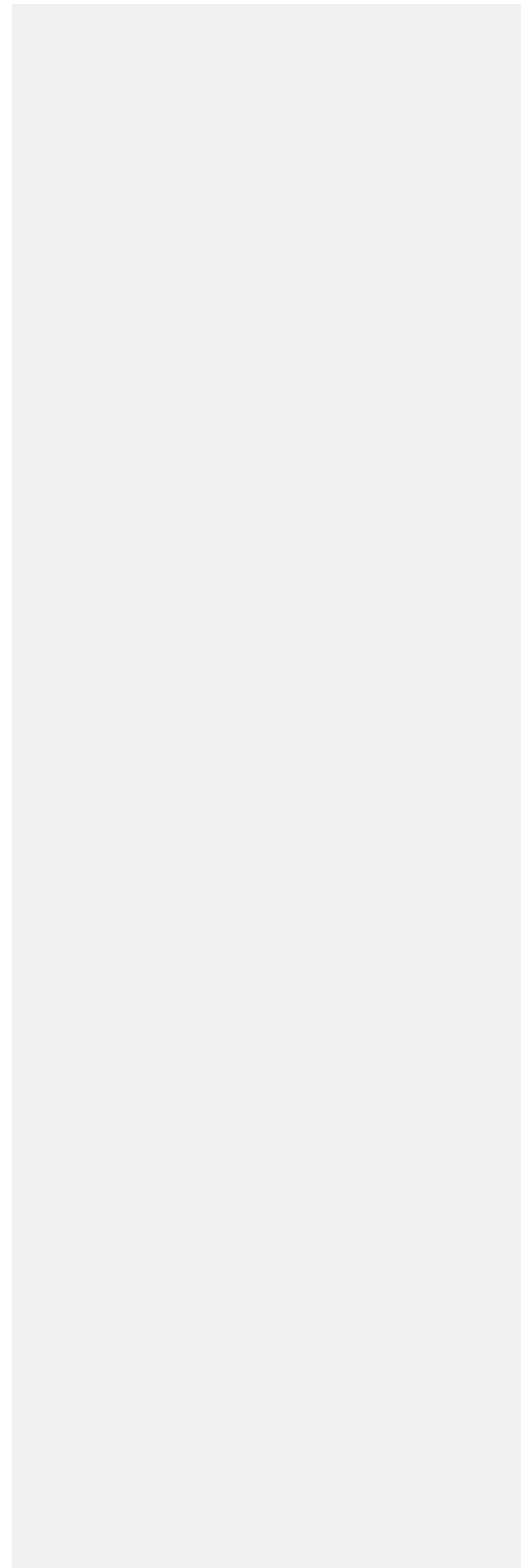

Southwest Power Pool, Inc.

CONTENTS

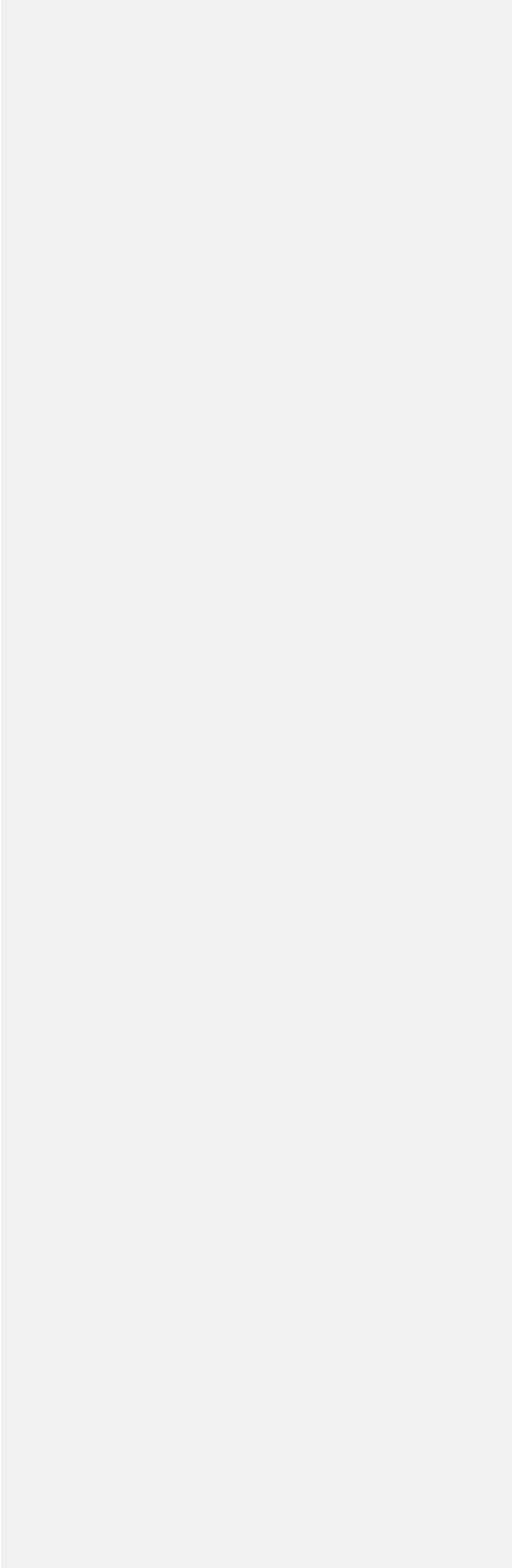

SECTION 1: INTRODUCTION

Purpose

This manual establishes consistent modeling data requirements and reporting procedures for the development of Near-term and Long-term Transmission Planning Horizon models necessary to support analysis of the capability, reliability, and suitability of the SPP Transmission System. This section describes the applicability of entities, data owners, equipment, and data submitters to which this manual is germane.

The latest modeling data requirements and reporting procedures for the Planning Coordinator's planning area, the "SPP MDWG Model Development Procedure Manual" jointly developed with each of the PC's Transmission Planners, can be found on the SPP corporate website, www.spp.org. Additionally, the schedule for submission of data and the list of MDWG models (case types/scenarios) can also be found on the SPP corporate website, www.spp.org. The schedule for model development will also be sent with the first data request.

Scope of Applicability

It is well understood that transmission system modeling is a complex process predicated upon accurate and comprehensive data collection, review, and compilation. The SPP Model Development Working Group recognizes that to properly develop SPP Transmission System models, a constituency of responsible entities must collaborate in the model building effort. The transmission system subject to the SPP OATT including facilities 60kV and above must be accounted for in the SPP Transmission System models. Therefore, consistent with both the applicability of the NERC Data for Power System Modeling and Analysis Reliability Standard (MOD-032-1)¹, and the provisions of the SPP Open Access Transmission Tariff (OATT), as well as good utility practice, this manual is applicable to the following NERC-registered and non-NERC-registered entities:

- Planning Coordinator;
- Balancing Authority;
- Transmission Service Provider;
- Transmission Planners;
- Transmission Owners² of equipment within the SPP Planning Coordinator planning area and/or of equipment that is part of the SPP Transmission System;
- Owners or lessors of generating units, including Generator Owners, within the SPP Planning Coordinator planning area of Network Resource(s) designated by the SPP OATT and/or who have submitted a Generation Interconnection Request consistent with the SPP OATT.
- Resource Planners;
- Distribution Providers;
- Network Customers receiving Network Integration Transmission Service pursuant to the SPP OATT for designated Network Load and/or having arranged Point-To-Point Transmission Service for non-designated load;
- Native Load Customers of an SPP Transmission Owner;

¹ The NERC petition to remove the Load Serving Entity (LSE) registration was approved by 153 FERC ¶ 61,024, issued 15 October 2015. Therefore, the LSE registration is not discussed in this manual.

² Capitalization is intended to include transmission-owning entities as defined in the NERC Glossary of Terms, as well as defined in the SPP OATT.

- Transmission Customers pursuant to the SPP OATT.

It is noted that within the SPP Region, consistent with SPP Regional Transmission Organization (RTO) procedures and the SPP OATT, SPP serves as both a Balancing Authority³ and Transmission Service Provider for the SPP Transmission System.

Applicable Data Owners

A subset of the applicable entities annotated above comprise the Data Owners subject to the modeling data requirements and reporting procedures of this manual:

- Balancing Authority is responsible for submitting modeling data for aggregated existing and future load, integrated resource plans, and interchange obligations corresponding to the case conditions specified.
- Transmission Service Provider is responsible for submitting modeling data for their existing and future service commitments and obligations corresponding to the case conditions specified.
- Distribution Providers are responsible for submitting modeling data for their aggregated existing and future load, and interchange obligations corresponding to the case conditions specified.
- Transmission Owners are responsible for submitting modeling data for their existing and future Transmission or sub-transmission equipment that they own or maintain.
- Owners or lessors of generating units, including Generator Owners, are responsible for submitting modeling data for the existing and future generating equipment that they own or maintain.
- Resource Planners are responsible for submitting modeling data for their existing and future long-term resource adequacy plan(s) of specific customer load demand and energy requirements, corresponding to the case conditions specified.
- Network Customers are responsible for submitting modeling data for their existing and forecasted load, existing and forecasted load transactions, as well as existing and forecasted resource transactions corresponding to the case conditions specified.
- Native Load Customers are responsible for submitting modeling data for their existing and forecasted load corresponding to the case conditions specified.
- Transmission Customers are responsible for submitting modeling data for their existing and forecasted transactions utilizing the SPP Transmission System, serving Network Load, or sales of Network Resources corresponding to the case conditions specified.

³ For Eastern Interconnection equipment only. WAPA-UGPR independently operates the WAUW BA area within the Western Interconnection for equipment which is under the SPP OATT.

Applicable Data Submitters

The Data Owner shall be the Data Submitter, subject to the modeling data requirements and reporting procedures of this manual. A Data Submitter may be designated as the entity who takes responsibility for collating, formatting, and corresponding a Data Owner's modeling data to SPP, as Planning Coordinator, in the approved format. A Data Submitter may be delegated only if the following are completed:

1. Data Submitter is designated in writing, showing mutual agreement by the Data Owner and Data Submitter.
2. Written notification is provided to SPP, as Planning Coordinator, regarding the specific data (e.g., load at bus X; generating unit Y; transmission branch Z) for which the Data Submitter will be responsible for.

Responsibility for the timely and accurate submission of Data Owner information to SPP, as Planning Coordinator, resides with the Data Owner.⁴ When a Data Owner delegates the submission of data to a Data Submitter, all communication that would otherwise be sent to the Data Owner alone, will be copied to the Data Submitter.

A Data Owner's submitted data shall not modify another Data Owner's data without explicit consent. Data Owners are encouraged to coordinate data submissions that may impact another Data Owner's system.

⁴ When delegated, the Data Submitter is not responsible for validating data provided by the Data Owner.

Applicable Equipment

The modeling data required from Data Owners supports both the creation of the Electric Reliability Organization (“ERO”), or its designee, Interconnection-wide modeling cases, and the other Near-term and Long-term Transmission Planning Horizon cases required under the SPP OATT⁵. Planned equipment, as differentiated from existing equipment, consists of equipment expected to be in-service for the case conditions specified (e.g., month; year). Existing or planned⁶ equipment for which non-equivalenced⁷ modeling data shall be reported include, but are not limited to:

1. All Facilities comprising the BES.
2. All non-BES equipment 60 kV and above, subject to the SPP OATT⁸.
3. All BES or non-BES equipment that includes a normally-open point that, when closed, shifts load or creates a network path affecting the SPP Transmission System.
4. All non-BES equipment interconnecting within the SPP Transmission System or interconnecting the SPP Transmission System with non-SPP Transmission System(s), subject to the SPP OATT⁹.
5. All non-BES equipment known to have a significant interaction with the BES, including reactive resources.
6. All direct-current connections within the SPP region or interconnecting to Transmission outside of the SPP region.
7. All Network Resource generation assets, subject to the SPP OATT¹⁰, excluding Small Generating Facilities (< 2MW).
8. All Network Resource (pursuant to Item 7) generator step-up transformers and generator interconnection equipment. Generator interconnection equipment shall include, at a minimum, collector electrical equivalent representations, where applicable.
9. All Resources that are registered in the SPP Integrated Marketplace, including the transmission equipment necessary to delivery that Resource to the SPP Transmission System when the registered Resource is not directly connected to the SPP Transmission System.
10. All Network Load, subject to the SPP OATT¹¹.
11. All firm power purchases served by SPP Network Resource(s) and firm power sales sunk to SPP Network Load, including all firm power transactions that result in an area interchange.

Other information regarding equipment not specified above may be requested by SPP, as the Planning Coordinator, or by Transmission Planner(s) for modeling purposes, as necessary. Likewise,

⁵ Pursuant to the provisions of the OATT, equipment below the typical 100kV demarcation of the BES must be accounted for in the SPP Transmission System models.

⁶ As part of the MDWG model building process to support of the TPL-001-4 R1 model building requirement

⁷ Equivalencing is a general technique that substitutes power system equipment with a simplified representation that closely approximates the characteristics and behavior of the actual equipment.

⁸ Sixth Revised Volume No.1, Attachment AI, Part II-1.

⁹ Sixth Revised Volume No.1, Attachment AI, Part II-2.

¹⁰ Sixth Revised Volume No.1, Part III-30.

¹¹ Sixth Revised Volume No.1, Part III-31

consistent with MOD-032-1 Requirement R3, the Planning Coordinator or Transmission Planner may request additional data or clarification regarding technical concerns with modeling data submitted. Written notification will typically be communicated through electronic means (e.g., email) to the Data Submitter and/or Data Owner and will include the technical concerns with the data submitted. Upon receipt of written notification, the Data Submitter and/or Data Owner shall respond to the notifying Transmission Planner or SPP, as the Planning Coordinator, with either updated data or an explanation with a technical basis for maintaining the current data in accordance with the reporting procedure schedule (“schedule”) jointly developed by the Transmission Planners and Planning Coordinator.

Accountability

SPP, through coordination with the MDWG, cannot be effective at building timely and accurate models without Applicable Entity participation. All Applicable Entities are responsible for providing the data necessary to model their Applicable Equipment. Likewise, Applicable Entities are accountable for meeting specific deadlines and milestones established by the MDWG, for model development, in the jointly developed schedule. The schedule will be made available to all Applicable Entities at the outset of each model-building period.

Clear and timely two-way communication between SPP, as Planning Coordinator, the Transmission Planners comprising the SPP PC, and Applicable Entities is vital to the successful compilation of modeling data, reporting, and ultimate production of accurate SPP Transmission System models. It is the responsibility of the Applicable Entity to communicate with SPP to establish the responsible contact for steady state, dynamic, and short circuit model data coordination.

Given that the MDWG relies upon Data Owner and Data Submitter input for the model building effort, the following are some of the established characteristics that support model-building best practices:

- Establishes a contact for model data coordination.
- Responds to model-building communications in a timely fashion.
- Data Owner begins coordinating data submittal well in advance of the initial model data submittal deadline.
- Submits model data ahead of established deadlines.
- Submit majority of model updates by initial model data submittal deadline.
- Ensures model data submitted is complete and accurate.
- Participates in MDWG conferences, calls and meetings.
- Performs a data integrity review of each model-building pass to identify and correct errors.
- Engages throughout the model-building process in a timely fashion.
- Keeps their respective managerial chain informed about model-building progress.
- Coordinates data submissions that may impact another Data Owner’s system.

Following each model-building cycle, SPP staff, in conjunction with MDWG members, will prepare a lessons-learned and modeling best practice recommendations assessment. This assessment will focus on challenges experienced by the preceding model-building cycle, attempt to identify root causes, and suggest improvements for subsequent model-building cycles.

MDWG experience has shown that some natural obstacles exist to achieving model-building best practices. The following cautionary situations are examples for the purpose of Data Owner and Data Submitter awareness during the model-building process:

- Appropriate lead times. Data Owners may rely on other entities to provide data; therefore, Data Owners should consider lead times when requesting data from others (e.g., Data Owner entity X is the Market Participant and Network Load registrant who serves a municipal customer). Knowing that source data may be more difficult or slower to obtain, the Data Owner should act as early as possible so not to delay the submission of data until late in the model-building process.
- An early and complete submission of a Data Owner's modeling data does not eliminate the need for the Data Owner to participate in all model-building passes. In many cases, model parameters that affect multiple Data Owners within a region (e.g., load, generation dispatch, and transactions) may change between model iterations. The aggregation of these changes can have a pronounced effect on the model data that Data Owners have submitted and emphasizes the need for checking/re-checking the integrity of a Data Owner's model representations in each model iteration.

During each model iteration, an assessment of model-building progression and participation may be performed. Given that incomplete or late data submission has a tremendous impact upon the ability to meet the model-building schedule, any Data Owner who seeks to submit late data will be obligated to present before the MDWG about how proposed model changes will impact the models themselves, as well as impacts to the overall modeling schedule. The MDWG has the obligation to report its progress and achievement of model-building milestones to various SPP working groups/committees.

In cases where an Applicable Entity has not participated or otherwise supported MDWG efforts in good faith towards the achievement of published milestones, the MDWG may report non-participating entities to the TWG/MOPC.

General Data Reporting Responsibilities

The SPP data reporting entities are responsible for the following categories of system modeling data:

1. Steady-State
2. Short Circuit
3. Dynamics

Steady-State models are developed for an annual series of SPP cases, including an annual series of ERAG MMWG cases. Specific models are prepared and modified for use in SPP designated studies as required by SPP Regional Tariff and Planning Criteria.

Short Circuit models are developed annually using a subset of the Reliability Steady-State models. All base MDWG steady-state models will include sequence data (including applicable mutual line impedance data) for the SPP footprint. The following 3 versions of short circuit models will be built:

1. MDWG steady-state base model
2. MDWG steady-state with PSS@E Classical assumptions
3. Maximum Fault case

The Base MDWG Short Circuit models are built by performing the following steps:

1. Extract the SPP RAW and SEQ data with ties from the final MDWG steady-state model
2. Extract the first tier company's RAW and SEQ data without ties from the final SERC Short Circuit model built by the Short Circuit Database Working Group (SCDWG)
3. Merge the two data sets together

The Classical assumptions MDWG Short Circuit Models are built by performing the following step:

1. Apply Classical assumptions to the Base MDWG Short Circuit model as described in the PSS@E Program Operation Manual

Maximum Fault cases are built by performing the following steps:

1. Place in-service (Apply a status of '1') all SPP planned and available existing generation and transmission facilities to the Base MDWG Short Circuit model
2. Apply Classical assumptions

The Dynamics Model is also updated annually with current generator unit information. Steady-State models are used in conjunction with dynamic data to run dynamic simulation.

System representatives should be responsive with good modeling techniques. SPP data models are used by individual systems for studying future needs in developing construction forecasts. Not planning a major expenditure by one year due to inaccurate data could be very expensive, since funding allocation for major construction projects requires more time resources. In addition, ATC, megawatt-mile and incremental losses are currently being calculated with these Steady-State models. With the large amount of interconnection within SPP, the impact of one system on another must be recognized and respected. Therefore, each system should prepare data consistent with its most recent official system forecasts in all data submitted to SPP including Energy Information Agency (EIA-411) Data. It is also important that the models represent the expected operation of the SPP system consistent with this manual and Planning Criteria.

Entities in the SPP Planning Coordinator region that are not members of the SPP but required to submit data (i.e. IPPs, Municipalities) will submit data directly to the Transmission Owner or Balancing Authority in which their system resides. Upon review (i.e. data accuracy, quality) by the Transmission Owner or Balancing Authority the data will then be provided to the SPP during the annual MDWG case type update process. The data submitted will be in the standard PTI format as specified in the MDWG Model Development procedure manual. All non-SPP members that are responsible for submitting this data should directly coordinate with the Transmission Owner or Balancing Authority on timing for sending data, as well as any special requirements in data formatting.

In an effort to determine who is collecting/submitting data for whom, all NERC registered entities within the SPP PC footprint (MOD-032-1: applicable to BA, GO, LSE, RP, TO, TP, and TSP) shall fill out the data coordination workbook to notify SPP if data is being submitted directly to SPP or through some other entity(ies) on behalf of your company. Likewise, SPP shall be notified if your company is submitting data on behalf of another entity(ies).

Confidentiality and Proprietorship

The representation of future system elements in SPP data models is not an agreement to construct these elements when shown in the models or at any time. The configuration of each model system only reflects the necessary changes that the individual model system needs for maintaining reliable operation. The results of studies obtained through use of the data models developed by SPP will be the sole responsibility of the receiving party. The recipient of SPP data models must assure confidentiality and proprietorship.

Schedule

As with all schedules, the meeting of deadlines is most critical. All system representatives must familiarize themselves with the schedule well in advance of all deadlines. This will alleviate any problems with the timing of data submittal and data reviews. The [schedule](#) for model development will be sent with the first data request as well as posted on the SPP corporate website, www.spp.org.

Steady-State and Short Circuit Model Development

The MDWG Steady-State and Short Circuit models are developed using data gathered through the SPP database Model On Demand (MOD) in conjunction with the Data Submittal Workbook. MOD data is divided into three parts: a Base Case, Projects, and Profiles (Bus, Loads, Generation, and Device Control). Modeling updates for transmission system topology can be made by submitting a Project to MOD. Non-topological modeling updates that are season specific can be made by submitting Profiles to MOD. Additional required data is submitted through the Data Submittal Workbook which is identified in the data preparation section of this manual.

SPP MDWG Steady-State and Short Circuit Models are published according to the approved schedule.

AC Contingency Analysis

SPP will perform AC Contingency Analysis on all models contained in the steady-state case type set.

The purpose of this contingency analysis is to validate the models. Member updates for errors found due to contingency analysis are to be submitted during the next member data submission period per the latest [MDWG model building schedule](#).

Dynamic Model Development

Introduction

The MDWG Dynamic Models include full MMWG cases and machine reduced cases. The initialized no-fault models can be solved with quarter-cycle and half-cycle time steps. The MDWG Dynamic model Update is used to support SPP reliability studies and ERAG MMWG Dynamic model requirements. It is important for all generating entities that interconnect to the SPP transmission to support the Regional Transmission Organization with current detailed dynamics data in the proper SPP model format. The current MDWG Dynamic Model Format is PSS@E dynamics DYRE and RAWD formats.

The Dynamics Model data includes:

1. Steady-State models
2. Dynamics model data in Siemens PTI PSS@E DYRE format
3. User written model source and object code (includes wind farms)
4. ERAG MMWG System Dynamics Database (SDDB)
5. SDDB data update worksheet

SPP MDWG Dynamic Models are published according to the schedule in Section 15 B.

MODEL DEVELOPMENT

Data Preparation

The following section describes important items that must be followed in the development of a steady-state model in preparing the data for publishing new models or updating existing models.

1. The data listed in Attachment 1 of the NERC Standard MOD-032-1 located on the [NERC](#) website.
2. MOD data should be kept current for each pass during the MDWG model build.
3. The Data Submittal Workbook contains informational data as well as modeling data that Data Submitters shall keep current for each pass of the MDWG model build.
4. Transaction – Firm and non-firm reservations with other entities that shall be coordinated before submission to SPP (Reference appendix VIII for more information).
5. Generator Data – Required generator data that is not otherwise captured in the models.
6. SPP Modeling Assignments – Contains PSS@E modeling area, owner, zone, and bus range information pertinent to SPP.
7. Load Mapping – Identify loads not served by native Control Areas.
8. Data Dictionary – List of all buses in the models that includes long names, voltage level, area, owner, and EIA plant codes.
9. Interregional Ties – PC to PC branch and transformer ties that shall be coordinated before submission to SPP.
10. Outages – Outages known during the annual model building process for buses, generators, branches, transformers, and shunts with a duration of at least six months shall be modeled. Data Submitters are responsible for annotating known outages to be modeled within the data submittal workbook, as well as ensuring that the known outages are correctly modeled in the appropriate season(s) when the known outage is scheduled. MOD projects shall be submitted with effective dates corresponding to the scheduled period of the known outages.

Table 1: Season Date Range and Cutoff Dates

Season	Date Range	Cutoff (On or Before)
Spring	April 1 – May 31	May 1
Light	April 1 – May 31	May 1
Summer	June 1 – September 30	August 1
Summer Shoulder	June 1 – September 30	August 1
Fall	October 1 – November 30	November 1
Winter	December 1 – March 31	February 1 (yyyy+1)*

*Example of Winter: 12/1/2017 – 3/31/2018; yyyy+1 = 2018

Steady-State and Short Circuit Data Format

PSS@E and MOD Users

The transmission modeling software approved by the SPP membership for performing planning and reliability studies is the Power Technologies Incorporated, Power System Simulator for Engineering (PSS@E) software. Data submitted for the building of the base SPP MDWG case types (models) needs to be in a format consistent with that used in PSS@E. The data shall be submitted via the SPP Models On Demand (MOD) Web Portal. Data submitted should be compatible with the MOD and PSS@E versions currently specified by SPP.

Non-PSS@E and Non-MOD Users

For those non-PSS@E users, load and generation profile data may be submitted via the Profile Submission form provided by SPP. SPP will aid with the submission of all other steady-state data in the correct PSS@E and MOD data formats. Any version changes will be discussed in the annual training provided by SPP.

Dynamic Data Format

PSS@E Users

Dynamics data needs to be submitted in the form of a flat text file or dyre file compatible with Siemens PTI PSS@E dyr file software. Dyre file submittals can be of changes to individual components from the existing dyre entries or of entire new representation of machines. Dynamic ready models are developed using the PSS@E software program. The data should be submitted via [GlobalScape](#) or email. Data submitted must be compatible with the PSS@E version currently specified by SPP.

Non-PSS@E Users

Dynamics data needs to be submitted in the form of a flat text file or dyre file compatible with Siemens PTI PSS@E software. Siemens PTI PSS@E Software contains dyre file models for most conventional machines, exciters, governors, SVCs, HVDC ties, wind resources, and solar resources. SPP Modeling staff will work with the responsible entity or its designee to translate operational test data into the appropriate dyre file format compatible with the PSS@E version currently specified by SPP.

The members are expected to contact the SPP Modeling Staff if there are any additional questions regarding the data format.

Responsible Entities

Data owners are responsible for providing the data necessary to model their assets to its Transmission Planner(s) and Planning Coordinator(s) as described in this document. Data owners and their respective data submission responsibilities are noted in the NERC standard MOD-032-1.

1. Generator Owners (GO) and Resource Planners (RP) are responsible for submitting modeling data for their existing and future generating facilities respectively.
2. Load Serving Entities (LSE) are responsible for submitting modeling data for their existing and future load corresponding to the case types developed.
3. Transmission Owners (TO) are responsible for submitting modeling data for their existing and future transmission facilities.
4. The Planning Coordinator or Transmission Planner can request other information necessary for modeling purposes from the BA, GO, LSE, TO, or TSP.

Typical Annual Models

Season		Season	
1	Annual Spring Peak	9	Annual + 1 Summer Peak
2	Annual Summer Shoulder	10	Annual + 1 Fall Peak
3	Annual Summer Peak	11	Annual + 1 Winter Peak
4	Annual Fall Peak	12	Annual + 2 Summer Peak
5	Annual Winter Peak	13	Annual + 2 Winter Peak
6	Annual + 1 April Minimum	14	Annual + 6 Summer Peak
7	Annual + 1 Spring Peak	15	Annual + 6 Winter Peak
8	Annual + 1 Summer Shoulder	16	Annual + 10 Summer Peak

The typical yearly models developed by the SPP MDWG, as identified within the NERC TPL reliability standards, encompass both near-term (years one through five) and longer-term (years six through ten) transmission planning models. The SPP models are defined in the **Annual Models** table above with those transmission planning models representing the near-term planning horizon consisting of the MDWG case types 1 through 13 and those representing the longer-term planning horizon consisting of the MDWG case types 14 through 16. The longer-term models may be incremented or additional models may be included as required to support ERAG MMWG.

The annual series of models are developed by SPP staff with input from the Model Development Working Group and the Transmission Working Group.

The [schedule](#) for submission to data and list of MDWG models ([case types](#)) can be found on the SPP corporate website, www.spp.org.

Transactions modeled in all base cases should be limited to expected firm schedules and should not include other transfers such as emergency power or opportunistic economy energy even though they may be provided for in contractual agreements. Due to FERC’s ruling of Roll-over rights, Long Term Firm Transactions should be considered in the models that extend into the future even if the transaction has a stop date. For a transaction to be considered firm, the transaction must be confirmed at both the source end and the sink end. Southwest Power Pool will do its best to confirm delivery of transactions outside of the Pool boundaries.

Firm transmission load includes capacity dependent interruptible loads with buy through provisions. In other words load that may be interrupted if the source runs out of capacity should still be modeled if the load has a choice and opportunity to purchase power from another source. This firm transmission load should be modeled in all cases. The load modeling entity is responsible for scheduling the power from a source and updating the transaction worksheet (see Appendix VIII).

Load Forecast

Load forecasting methodologies vary throughout the electric industry. SPP depends on load forecasts from Data Submitters to apply to the planning models. These load forecast amounts are to be Non-Coincident to the SPP region, meaning that the hour that a Data Submitter’s system experiences a peak demand for a particular season, might not be the same hour that SPP, as a region, experiences a peak demand. In order to bring consistency and equivalency to the load forecast data submitted to SPP, load forecast data shall be based on a 50/50 forecast.

A 50/50 load forecast relates to a forecasted load amount having an equal probability of being either higher or lower than the amount forecasted. The forecasted load value is at the 50th percentile of a normal or similarly shaped distribution curve and is typically discussed in terms of exceedance such that there is a 50% probability that the load forecast will be exceeded due to abnormal weather.

Some studies may require load forecasts other than a 50/50 load forecast and may be requested for such special studies. For example, a 90/10 load forecast has a 10% probability that the load forecast will be exceeded, which means the load forecast amount is higher than a 50/50 load forecast amount and would be considered atypical for general SPP transmission planning purposes.

There are various methods used to develop such forecasts and the forecasts are dependent upon many factors such as historical load values, temperature, humidity, economic forecasts, time of day, day of week, holidays, special events, and load uncertainty. Other factors, some of which are controllable, also impact the amount of forecasted load. Controllable Demand Side Management (DSM) and Distributed Energy Resources (DERs) are such factors.

Demand Side Management consists of activities or programs that an entity invokes to achieve a reduction in Demand. DSM consists of controllable and non-controllable systems. Load forecasts shall not be reduced for application of controllable DSM. There is control over whether or not the load will be shed by an operator or end-user and therefore cannot be guaranteed that the load will be reduced during peak hours. Load forecasts should be reduced for application of non-controllable DSM. This load has a high probability of being shed during peak hours without manual intervention. Distributed Energy Resources are power resources on the distribution system that can be aggregated together to provide power to meet Demand. For purposes of transmission planning, it is recommended that Distributed Energy Resources should not be applied to a Data Submitter's load forecast amount for incorporation into the SPP planning models.

~~When it becomes necessary or desirable to make changes in delivery point facilities, to upgrade, retire, replace or establish a new delivery point, including metering or other facilities at such location, the provisions set forth in Attachment AQ of the SPP Open Access Transmission Tariff (OATT) shall apply. Loads that have completed the Attachment AQ process or any other applicable SPP process, and have a signed Interconnection Agreement (IA), or are in the process of finalizing an IA should be included in the Data Submitter's load forecast. SPP will reject any MOD projects or PSS@E idevs that attempt to add, delete or modify delivery points that have not been studied either through the Attachment AQ or any other applicable SPP process. Data Submitters are required to appropriately tag MOD load projects in MOD.~~

When it becomes necessary or desirable to make changes in delivery point facilities, to upgrade, retire, replace or establish a new delivery point, including metering or other facilities at such location, the provisions set forth in Attachment AQ of the SPP Open Access Transmission Tariff (OATT) shall apply. Loads that have completed the Attachment AQ process or any other applicable SPP process, and have a signed agreement, or are in the process of finalizing a signed agreement should be included in the Data Submitter's load forecast. SPP may reject any MOD projects or PSS@E idevs that attempt to add, delete or modify delivery points that have not been studied either through the Attachment AQ or any other applicable SPP process. Data Submitters are required to assign the appropriate type and status to load projects in MOD.

Summary of Data Submitter's load forecast data comprisal:

1. Non-coincident to the SPP region
2. 50/50 load forecast
3. Load forecast amount includes non-controllable Demand Side Management
4. Load forecast amount excludes controllable Demand Side Management
5. Load forecast amount excludes Distributed Energy Resources (recommended)

Seasonal peak models developed by SPP include: Summer Peak, Winter Peak, Spring Peak, and Fall Peak. These four seasonal models are built to represent the expected coincident seasonal peak based on each Data Owner/Data Submitter system peak load. Data Owner/Data Submitter peak load may not be coincident to the SPP Balancing Authority coincident peak.

In addition to the seasonal peak models, SPP develops two off-peak models. They include: a Light Load condition and a Summer Shoulder condition.

The Light Load model is developed with the intent to capture a Data Owner/Data Submitter system minimum load during the spring timeframe.

The Summer Shoulder model, also known as the seasonal on-peak average model is defined to be 70% - 85% of the total Summer Peak load level depending on the Data Owner/Data Submitter system.

Spring Peak (G):	April 1 st through May 31 st
Summer Peak (S):	June 1 st through September 30 th
Fall Peak (F):	October 1 st through November 30 th
Winter Peak (W):	December 1 st through March 31 st
Light Load (L):	April 1 st through May 31 st
Shoulder (SH):	70% - 85% of Summer Peak model

Data Owners of load that is pseudo-tied into SPP shall submit load forecasts to both SPP and the entity in which the load is embedded. Owners of load that is pseudo-tied out of SPP should submit load forecasts to the entity in which the load is embedded.

External load is load not affiliated with load forecasts submitted by SPP Data Submitters to SPP for planning model building purposes.

Area Summary Report

The Area Summary Report is an important part of data preparation and should be the initial step of the update process. This report, though not part of the steady-state input forms, is an important part of the data coordination process. As such, the report should be distributed to all appropriate systems at least one week before the initial update data is due at the SPP Office. The standard area abbreviations listed in Section 6-B should be used on the area summary report and in the steady-state input data of area interchange and transactions. The following sequence of steps is to be used in completing this report:

1. The system name and area number, along with the name and phone number of the person that prepared the report, should be entered at the top of the form in the appropriate location.

2. The area slack bus and bus number. The area slack bus is to adjust for individual system losses only. It is not necessary for the area slack bus to be used for area load control in actual operation. Generation dispatch should be made to prevent the area slack bus from going to negative power output or power output above the stated rating of the unit when accounting for area losses. It is best that the area slack bus not represent a base load unit. The estimated slack bus generation should also be entered (Item 7). There should be room left on the slack bus for generation movement up & down.
3. For consistency, it is important that each system continue using a particular area slack bus rather than choosing a different bus from year-to-year, unless a specific reason exists to justify such a change. There is a new row on the Area Summary Sheet to identify the slack bus. To aid in solution time of the cases, the area slack bus should be located on a relatively strong portion of the system.
4. The case year and season should be entered in the appropriate locations in chronological order.
5. The current system official load forecast should be entered as net load (Item 6).
6. The estimated losses should be entered (Item 5). The reference cases can be used as a starting point to estimate system losses.
7. Load equals net load minus estimated losses (Item 4).
8. Purchases and sales should be entered (Item 2). These values must be coordinated with the parties involved in the interchange transaction prior to data preparation. The algebraic sum of these transactions should be equal to the total area interchange.
9. Net power (Item 3) must equal net load (Item 6). Generation (Item 1) is equal to the net power plus interchange.

Tie Line Coordination

Each SPP system will receive a tie-line data comparison summary for the initial base case and after the final models are published. The member **must** coordinate with its neighbors on the tie line representation in the models being developed.

This coordination should consist of:

1. Agreement on which bus is to be metered for area loss accounting,
2. The in-service and out-of-service dates, if applicable,
3. Tie line characteristics and ratings
4. System responsible for supplying the update data.

SPP Member tie data (Intra-SPP) is maintained in a MOD Project file. The majority owner of the tie is responsible for maintaining the tie's steady-state, sequence, and ratings data.

SPP tie data with external entities (Inter-PC) is maintained in the MMWG PC tie line list. Entities must submit changes using the latest list, which will be posted with the latest case set. Changes are to be highlighted in order for SPP Staff to easily discern the submitted changes. The file name shall contain the company name of which is submitting the change. There will be other lower voltage SPP ties which are not listed in the NERC list. They will be checked using the SPP tie line reports.

Line and Transformer Data

Additions to the system tend to move from year-to-year based on changing load growth forecasts and budget requirements. As a result, future lines and transformers may move through several

future cases. Line and Transformer Data is contained in MOD Projects and phases. The Project Type, Status, and Phase Effective Date determine if the data will be included in a particular model. The line and transformer data formats are found in Section 5.

The following steps should be considered when preparing line and transformer data:

1. The device code (Bus, Branch, Transformer) specifies what data is being added to the base case. The action code (Add, Modify, Delete) specifies the action to be taken with the Project data. Specifying the deletion of a bus will require a similar record to delete all associated or connected devices with the bus (lines, generators, loads, transformers, etc.) from the base case.
2. The "from bus," "to bus", and circuit number identify the line or transformer. The order in which bus numbers are entered is important for tie lines to identify which bus is metered for loss accounting in some data formats. The "from bus" is assumed to be the metered end (unless the "to bus" is entered with a negative) and the "to bus" area will collect loss responsibility. For transformers, this order is also important in all formats because it specifies to which bus the Load Tap Changer (LTC) will attempt to maintain voltage and/or which bus is tapped. The code U in the branch data allows the user to select proper metered and tapped side by always entering the tapped side as the "from bus" or first bus number after the change code. The "from bus" is the metered end unless the "to bus" or second bus number is a negative number. Remember to include the circuit identifier.
3. The positive, zero, and negative sequence branch impedance data shall be provided on a 100 MVA base (per unit value). The smallest allowable reactance is 0.00011 P.U. on a 100 MVA base. Reactance values less than minimum will cause the steady-state program to treat the line as a zero impedance line to reduce solution time.
4. The positive, zero, and negative sequence line charging data (conductance and susceptance) shall be provided on a 100 MVA base (per unit value) as applicable. A default value of zero will be assumed if no data is provided. Line charging data will be divided in the appropriate units depending on the specific format being utilized. Accuracy is needed to ensure a proper voltage profile in the model.
5. Each SPP member shall rate transmission circuits in accordance with the SPP Planning Criteria (Section 7.2). This criterion calls for each member to compute, at a minimum, summer and winter seasonal ratings for each circuit element. Each Base Case (Network) and Project branch, two-winding and three-winding transformer must have a specified rate A (normal) and rate B (long-term emergency) for spring, summer, fall, and winter. The ratings data format is in the MOD Procedure Manual.
6. The transformer tap and tap limits shall be specified. The use of LTC transformers should be kept to a minimum to help reduce the case solution time. Using LTC transformers for local area voltage control where no such transformer exists should be avoided. In general, regulating transformers should not be located at a bus with a regulating generator or other voltage regulating device; however, there may be exceptions based on current system topology and operating conditions.
7. Circuit mileage should be entered in the appropriate line length field of branch data. Ownership data for the line should also be entered in the appropriate fields of branch data. This mileage and ownership data will be used to validate and calculate

Megawatt-mile for the SPP Regional Tariff. Circuit mileages should be coordinated on all jointly owned lines. Invalid line lengths result in inaccurate revenue allocations.

8. All NERC flowgates must be included in the data submitted by each region to the MMWG such that those flowgates are not equivalenced in the steady-state models. A flowgate is a selected transmission element or group of elements acting as proxy for the transmission network representing potential thermal, voltage stability, rotor angle stability, and contractual system constraints to power transfer. Enough detail should be added to model the flowgate accurately.
9. Transformer connection codes¹² and transformer winding angle (phase displacement) shall be provided. The connection code data incorporates concepts of the transformer core type, the vector group (phase differences between windings, standardized with clock notation indicating phase displacement), and physical conductor orientation. The transformer winding angle further specifies the inherent phase shift between transformer windings based upon configuration (vector group). Data Owners are reminded that changes to connection codes do not automatically alter the modeled phase displacement used for positive sequence load flow calculations.

Bus Data

For all SPP steady-state models, systems will model buses within their SPP allocated bus range (see Section 6-B). For the sake of consistency, the bus names and numbers should remain constant from case to case and year to year. All bus shunts will be modeled as switched shunt. The Switch Shunt may be locked. ~~Any changes to bus names or numbers will be documented on the SPP Expanded bus name list. This will include renumbering buses as well as adding new or removing old buses from the models.~~ When a change in bus voltage occurs, a new bus number will be given to the new higher voltage bus. This enables SPP to track when the old bus voltage changes. All interregional tie bus names should conform to the entries in the Master Tie Line Database as approved by the Regional MMWG Coordinators. All tie line bus names and numbers should be standard and unique within each area in all models in a case series. Changes in tie line bus names and numbers from one series to the next must be kept to a minimum to reduce changes in computer support programs. Unique generator bus names, base voltages, and unit id combinations should be consistent from case to case within a model series. ~~The SPP Expanded bus name list can be used as a quick reference for new names.~~ This will help ensure that the SPP bus names do not conflict with ERAG MMWG Standards.

The following steps describe options and data for most bus data formats:

1. The device code and the change code determine describes what action(s) are taken with the data supplied (addition, deletion, modification, etc...).

¹² Reference PSS/E Program Operation Manual section: Two Winding Transformer Zero Sequence Network Diagrams and Connection Codes or Three Winding Transformer Zero Sequence Network Diagrams and Connection Codes

NOTE: When a bus is deleted or removed from service, all associated network devices (lines, transformers, loads, generators, etc.) must also be deleted or connected to a different bus in removed from the applicable steady-state model(s) within the Project.

1. Although voltage codes have no uniform association with voltage classes, historical consistency is encouraged amongst entities within a highly integrated network. As previously mentioned, the bus names and numbers should remain constant unless there is a particular reason for changing them. This will aid the consistency of the models developed. Bus names can have may be up to 12 characters with the first character, preferably, alphabetic rather than numeric. The name should be left justified. Characters which can aid in filtering or association are allowed excluding the following characters: commas, asterisks, single quotes and double quotes. The eighth last character field of the bus name should be the SPP voltage code described as follows. The historical SPP voltage code list shown below is recommended, but not required:

1 - Below 69 kV	2 - 69 kV	3 - 115 kV	4 - 138 kV	5 - 161 kV	6 - 230 kV	7 - 345 kV	8 - 500 kV	9 - 765 kV or above
-----------------	-----------	------------	------------	------------	------------	------------	------------	---------------------

The ninth through twelfth character fields of the bus name are reserved for the base kV designation (right justified). As associated with the voltage code, the generally used kV values are: 69.0, 115, 138, 161, 230, 345, 500 and 765.

1. For generator regulated buses, a desired voltage magnitude will be given. Generator buses should be modeled with operating characteristics as close to actual as possible. Generator ratings should also be specified for each generation bus (whether on or off-line) as described in SPP Planning Criteria Section 7.1. Generators shall model the gross output of the generating facility and explicitly model the station service auxiliary load. The practice of using generator for voltage support only (i.e. no real power output), should be avoided unless a synchronous condenser or static var controller physically exists on that bus or nearby in the system. When a generator is modeled offline (status 0), the MW (PGEN) and MVAR (QGEN) fields should be zeroed. Regulating transformers should not be located at a bus with a controlling generator or regulating shunt device.
2. Bus loads should be specified with the real and reactive values provided as a pair in all entries. The load should be modeled to reflect the expected in-service/out-of-service status.
3. When scaling area load, it is important to consider the reactive power as well as real power. This is particularly true when referencing a case of a different season. Realistic reactive load representation has a major effect on the overall case voltages. Reactive requirements are different for the various season models.
4. Capacitors, reactors, and SVCs represented in the models should be consistent with actual seasonal operation. These devices should be used in future cases calling for local area voltage support, rather than falsely regulating a bus. Attention should be

- Formatted: Highlight
- Formatted: Highlight
- Formatted: Font: Not Bold, Highlight
- Formatted: Highlight
- Formatted: Font: Not Bold, Highlight
- Formatted: Highlight
- Formatted: Font: Not Bold, Highlight
- Formatted: Highlight
- Formatted: Font: Not Bold, Highlight
- Formatted: Highlight
- Formatted: Normal, No bullets or numbering, No widow/orphan control
- Formatted: Highlight
- Formatted: No underline, Highlight
- Formatted: Highlight
- Formatted: No underline, Highlight
- Formatted: Highlight
- Formatted: Highlight
- Formatted: Highlight
- Formatted: Highlight
- Formatted: Highlight
- Formatted: Highlight
- Formatted: Highlight
- Formatted: Highlight
- Formatted: Highlight

given to these installations in cases that are referencing a different season model. Tertiary reactors should be modeled on the low voltage bus of transformers if the tertiary is not modeled explicitly.

Do not model existing or planned shunts on the Bus record. Shunts should be modeled in the Switched Shunt Record unless they are line shunts and trip when the line is opened. Bus shunt voltage bandwidth must be wide enough to prevent "hunting" of shunt value during steady-state solution of base case or contingency analysis. The switched shunts can be modeled as fixed shunts with specified B initial value.

Load Data

Load data is maintained in MOD via a profile file which is applied to the model. Profiles, Loads can belong to an Area that is not the same as the Bus Area. Refer to Section 5-A-3 for load data formats. The default solution technique will solve the case with Tie Lines and Loads. The Tie Lines and Loads solution option assumes that the Loads Area generation serves the load.

The Non-Scalable Loads will be identified in the Non-Scalable Load worksheet of the Data Submittal Workbook. This allows model builders to modify models without changing the loads that are constant.

Loads that are owned by municipal utilities should be modeled with an identifier in front of the number (i.e. Rayburn County load one should have the ID "R1"). These loads should be maintained in the Load Mapping worksheet of the Data Submittal Workbook.

Generator Data

Check Generator MW and Mvar output to ensure the unit is within the P_{MAX}, P_{MIN}, Q_{MAX}, Q_{MIN} and Mbase limits per testing requirements in SPP Planning Criteria 7.1.1. Generator MW shall be set to "gross" level with auxiliary load modeled explicitly. Q_{max} and Q_{min} values in the models should be based on unit test data. Intermittent resources (e.g., wind and run-of-river hydro) should not normally be dispatched beyond their net capability as established by SPP Planning Criteria 7.1 for the summer and shoulder cases. Energy storage (pumped hydro, battery, flywheel, etc.) shall be modeled with the generator rated capabilities and a dispatch amount (P_{gen}) no greater than the rated output that can be sustained continuously for a minimum of one (1) hour. Ensure accurate values of Z_R and Z_X. This data is not needed in normal steady-state and equivalent construction work, but is required for switching studies, fault analysis and dynamic simulation. For dynamic simulation, **this complex impedance must be set equal to the sub unsaturated transient impedance for those generators modeled by sub transient level machine models**, and to transient impedance for those modeled by classical or transient level models. Machine Base (M_{BASE}) and Zero Impedance (Z_{SOURCE}) values for the steady-state models must match dynamic data. The MDWG steady-state models will use the saturated subtransient impedance data for generators (X''_{di}). Future Generators that are in the models but are not budgeted for construction need to be identified in the Generator Data worksheet of the Data Submittal Workbook.

When modeling mothballed and future retired units, the P_{max}, P_{min}, Q_{max}, and Q_{min} values should be modeled as zero. Decommissioned units should be removed from the models.

Shortfall Guidance Process

A shortfall is defined as an instance of insufficient firm resource to supply firm load. Under no

circumstances in the Near-Term Transmission Planning Horizon shall generating resources be dispatched in excess of the firm transmission rights allotted to that resource. In the Long-Term Transmission Planning Horizon, if the resources within a modeling area and firm transactions from neighboring modeling areas are insufficient to serve customer load, the following should be investigated as potential modeling solutions to the shortfall:

1. Coordinate reciprocal non-firm transaction(s) with other modeling area(s). All parties are required to add their respective coordinated reciprocal record(s) to the transaction worksheet of the data submittal workbook.
2. Future generation resources that have progressed, at minimum, to the Interconnection Facility Study (per Attachment V, subsection 8.9) stage in the Generation Interconnection (GI) queue, may be modeled (in the Long-Term Transmission Planning Horizon models only) following these requirements.
 - a. The in-service date shall be based on the expected in-service date of the GI study.
 - b. In order to identify future GI queued generation, the unit name shall be the GI gen number (e.g. GEN-2017-898) and contain a unit ID of Zx (where x is any second ID designation appropriate in PSS@E).
 - c. Projects files that add future generation shall have the appropriate Type and Status which can be found in the SPP MOD Project Type/Status Matrix.
3. Future exploratory generation resources may be modeled in the Long-Term Transmission Planning Horizon models following these constraints:
 - a. In order to identify future exploratory generation, the unit ID of Zx (where x is any second ID designation appropriate in PSS@E) shall be used.
 - b. When available, exploratory generation should be based upon the host TO Resource Plan.
 - c. Projects files that add future generation shall have the appropriate Type and Status which can be found in the SPP MOD Project Type/Status Matrix.
 - d. The addition of exploratory generation shall be consistent with modeling practices that minimize the impact to power flows in neighboring transmission systems (e.g., exercise diligence in siting the exploratory generator topologically proximate to the load that uses its resource).

~~Note: The Generator Data worksheet data will be maintained to provide a convenient source of data for Member and SPP Staff use. Therefore accurate data in the Generation workbook is imperative. The official SPP generator data is in the MOD Base Case or Project~~

Formatted: Highlight

Remote Generation Modeling

Purpose

This procedure assures that members adhere to a uniform process when modeling remote generation in SPP.

Modeling Process

If a member acquires remote generation outside their Control Area (steady-state model numbered area), the following modeling process should be followed:

1. All buses should be assigned numbers that are in the host's control area bus number range.
2. Area Number/Name should be the host's control area number.
3. Zone Number/Name should be in the host's control area zone range.
4. Generation Owner Number should be the owner's designated ID number and percentage ownership.

- The generation recipient should coordinate the output level and the inter-area transfer with the host control area.

Transaction Update

The transaction workbook should be updated to show a transaction from the control area where remote generation is located to the generation owner control area. If the remote generation is owned by multiple owners, then multiple transactions should be modeled.

Steady-State Data Check List

The steady-state data check list should be used as an aid for ensuring good model data. As the data and preliminary runs are reviewed for each model, the items should be checked off. A copy of this form can be found in **Section 7**.

Facilities Transferred to SPP's Functional Control

The SPP FERC "Docket No. RT04-01-00 Volume 1", ***In the July 2 Order, the Commission: ... (7) ordered that SPP file a list of all transmission facilities that will be transferred to its operational control and revise the Operational Authority White Paper ("OA White Paper") or Membership Agreement, or provide some other binding document, to reflect SPP's clear authority to exercise day-to-day control over the appropriate transmission facilities within its footprint...***

Attachment AI to the SPP Regional Tariff contains the criteria for inclusion of facilities that are considered "**Facilities Transferred to SPP's Functional Control**". Transmission facilities meeting the definition set forth in Attachment AI must be included in the SPP MDWG Steady-State Models.

Owner Data and Line Mileage Data (SAS-70 Control)

Per SAS-70 requirements (i.e. – Loss calculations) SPP Loss models must be updated every June and October with current Owner Data and Line Mileage data. To meet the SAS-70 requirement the SPP models must include owner data and line-mileage data. SPP Staff will obtain this data from the MOD Base Case and Projects; therefore, it is important that Members keep the data current in MOD.

Zone Range Assignments

SPP Area

Refer to the most current SPP Area Zone Assignments.

MMWG Region

Region	Bus Numbers	Area Number	Zone Number	Owner Numbers
Entire System	100,000 to 899,999	100 to 899	100 to 1,899	100 to 1,199
NPCC	100,000 to 199,999	100 to 199	100 to 199 and 1,100 to 1,199	100 to 199
RFC	200,000 to 299,999	200 to 299	200 to 299 and 1,200 to 1,299 and 1,800 to 1,899	200 to 299
SERC	300,000 to 399,999	300 to 399	300 to 399 and 1,300 to 1,399	300 to 399
FRCC	400,000 to 499,999	400 to 499	400 to 499 and 1,400 to 1,499	400 to 499
SPP	500,000 to 599,999	500 to 599	500 to 599 and 1,500 to 1,599	500 to 599 and 800 to 899
MRO	600,000 to 699,999	600 to 699	600 to 699 and 1,600 to 1,699	600 to 699
ERCOT (future)	700,000 to 799,999	700 to 799	700 to 799 and 1,700 to 1,799	700 to 799

Data Transmittal

Transmitting data to the Southwest Power Pool can be accomplished as follows:

1. **Electronic** --- [GlobalScape](#)
2. **E-MAIL** --- SPPEngineeringModeling@spp.org

The preferred method of submittal is through the "SPP MDWG File Sharing Site", [GlobalScape](#). Include a file (excel, word, or equivalent) with description of data files submitted and which to which models they apply.

The transmitted data file should include the title of the first case and area name, followed by the changes to the first case, title of the second case and the area name, followed by the changes to the second case, etc. See Section 6-B for a sample file format. Case title lines should include the case title as in the following format examples: *04SP, *04FA, *04SH, *07SP (no spaces between characters).

Initial Run Review

After all systems prepare and submit data, an initial run is made which assembles all system data, checks for errors, and results in a solved case. The initial run shows all entered data and diagnostic messages. This data is shown first in the initial run printout. Each system should review the data changes and solved case, making corrections as needed in the subsequent runs.

1. **Area Interchange**
The area interchange report shows the area control bus, generation on the area control bus, and the net area interchange. The detail of area interchange among SPP systems is shown in the transaction data. The transaction workbook will include the NODE, Provider, and OASIS reservation number. The transaction workbook will use code DDD for transactions that do not have an OASIS reservation number. This data should be checked to ensure accuracy. Discrepancies in the transactions between reporting systems will be noted in the diagnostic messages.
2. **Tie Line Metering**
The tie line report shows the tie lines and inter-company power interchange for each system. The tie line metered end should be verified, and should reflect line loss responsibility as accurately as possible. Any changes should be coordinated with the neighboring company involved.
3. **Area Totals**
The system generation and load should be checked on the system area summary. This data should be near expected values. The detail of generation is shown in the generation summary. If load is not the expected value, individual bus loads listed in the steady-state detail report should be examined. If loads were scaled from a reference case, the scaling factor should be checked. The load power factor should also be checked as power factors change seasonally. Check Power-factor of loads. The load supplying entities for the MDWG case types will validate each load power-factor with the most current system snapshot that represents that models load level (summer peak, winter peak, light load).

4. Network

Basic to the accuracy of the steady-state model is the accuracy of the network. The layout of the system representation should be checked. Purely conjectural facilities should not be included. Planned facilities which were modeled in previous steady-state models and have since been delayed or cancelled should be removed entirely from the steady-state model. These facilities cause solution problems for some steady-state programs if left in the model with an off-line status. Planned projects, including reactive resources such as capacitor banks, are to be included in the models. These projects are to be added through MOD in accordance with the MOD Type/Status Matrix of the Web Based Steady-State Model Development Procedure Manual.

5. Review of Output

The steady-state report should be checked for the flow on major transmission lines and selected bus voltages. This check can locate unusual results, which does not necessarily mean that data is in error, but rather indicates that additional checking of the model may be appropriate.

6. Three useful reports for locating problems include:

- a. The voltage summary,
- b. The overloaded branch summary, and
- c. The generation summary.

a. Voltage Summaries

Low or high voltages may be caused by a number of factors. Shunt devices may be sized inappropriately. Capacitors should have a positive value and reactors should have a negative value. (Check the CAP/REAC column of the steady-state report). The bandwidth (difference between VSWHI and VSWLO) of switched shunt devices should be wide enough that switching one block of admittance does not move the voltage at the bus completely through the bandwidth, thus causing solution problems at the bus. It is recommended that the minimum voltage bandwidth be 4% if only switched shunts are used to regulate voltage. Switched shunts should not regulate voltage at a generator bus, nor should they be connected to the network with a zero impedance tie.

Transformer tap settings may also affect voltages. The steady-state report should be checked for tap settings. Particular attention to LTC-equipped transformers should be given to make sure the proper bus is regulated.

A tap setting of less than 1.000 on the tap bus results in an increase in voltage on the non-tap bus. A tap setting greater than 1.000 on the tap bus results in a decrease in voltage on the non-tap bus.

The inclusion of LTC regulation makes tap setting more important. With LTC-equipped transformers, fixed taps may also exist. The LTC tap range should be adjusted to compensate for the effects of fixed taps if necessary. The minimum and maximum number of ULTC and NLTC taps should comply with common industry standard practices.

Transmission line or transformer impedance errors may also affect voltages if the errors are large. See Section 6-A. for guidelines of typical transmission line or transformer impedance data.

b. **Summary of Overloaded Branches**

This summary shows each overloaded circuit, the flow on the circuit, and the normal and emergency ratings. Overloading may be caused by an incorrect rating. Both normal and emergency ratings should be given. Emergency ratings must never be less than normal ratings, though the ratings may be equal. The impedance of a circuit element or of a parallel element may also cause overloading. See Section 6-A for guidelines of typical transmission line or transformer impedance data.

c. **Generation Summary**

All buses with generation as well as all buses with voltage regulation are shown in this summary. Generators should not be modeled as unregulated buses.

The MW ratings, Mvar ratings, machine base (MBASE), and ZSOURCE must be supplied for each generator. Generator PMAX ratings should represent the net capability of each machine connected to the bus. Ratings should be adjusted seasonally in consideration of scheduled outages. The generation should be shown on the correct bus. Generation must not exceed the rating. Generator MBASE values should be equal to the nameplate MBASE rating of the unit. Each unit should be explicitly modeled and listed in the SPP Generation tab of the Data Submittal Workbook.

The generator workbook will be updated to include both the saturated and unsaturated impedance for each machine. Fuel types, especially wind farms, should be identified in the appropriate column.

The reactive output limits (MAX and MIN) should be realistic values as defined in SPP Planning Criteria. For generators, a general rule of thumb sets MVAR limits as:

- i. QT --- MAX = one-half of MW rating
- ii. QB --- MIN = negative one-third of MW rating

If the slack bus generation changes significantly from the input value, it indicates an error in the model data. Regulated buses are not limited to generators, but also include other equipment such as synchronous condensers and static var controllers. If the actual voltage does not match the desired voltage, a reactive limit will be reached. The desired voltage for each regulated bus should be checked seasonally.

The Generator Owners/Data Submitters of utility scale wind and solar resources shall provide an equivalent representation consisting of all collector bus(es) and the main power step-up transformer(s) from the collector bus(es) to the transmission point of interconnection (POI). Additionally, a single step-up transformer and feeder parameters for each connected generator model, from the generator terminals to a collector bus, shall be included in the equivalent representation, with wind/solar devices lumped together to represent the aggregate wind turbines or solar inverters in each collection network. The equivalent representation shall be an as-built representation (as reasonably as possible) with all transformer data reflective of manufacturer test report information. Any future changes or updates to equipment (wind turbines or solar inverters) or electrical topology shall include an updated equivalent representation to the Transmission Planner before submitting to the Planning Coordinator.

Generator facilities comprised of more than a single inverter (battery, flywheel, etc.) and other similar technology should have similar equivalent model representation. Figure 1 and Figure 2 below are illustrations provided for use as guidance for the equivalent

representations of such renewable resources; however, Figure 2 shall be the representation in the planning models.

Generator Owners/Data Submitters should coordinate with their host Transmission Owners to obtain valid SPP bus numbers for use in the equivalent representation of the generator resources. Bus names shall conform to the bus naming section of this manual. There are several industry best practice documents explaining how to represent equivalent representation of generator resources (examples: WECC Wind Power Plant Power Flow Modeling Guide and PV Plant Power Flow Modeling Guide).

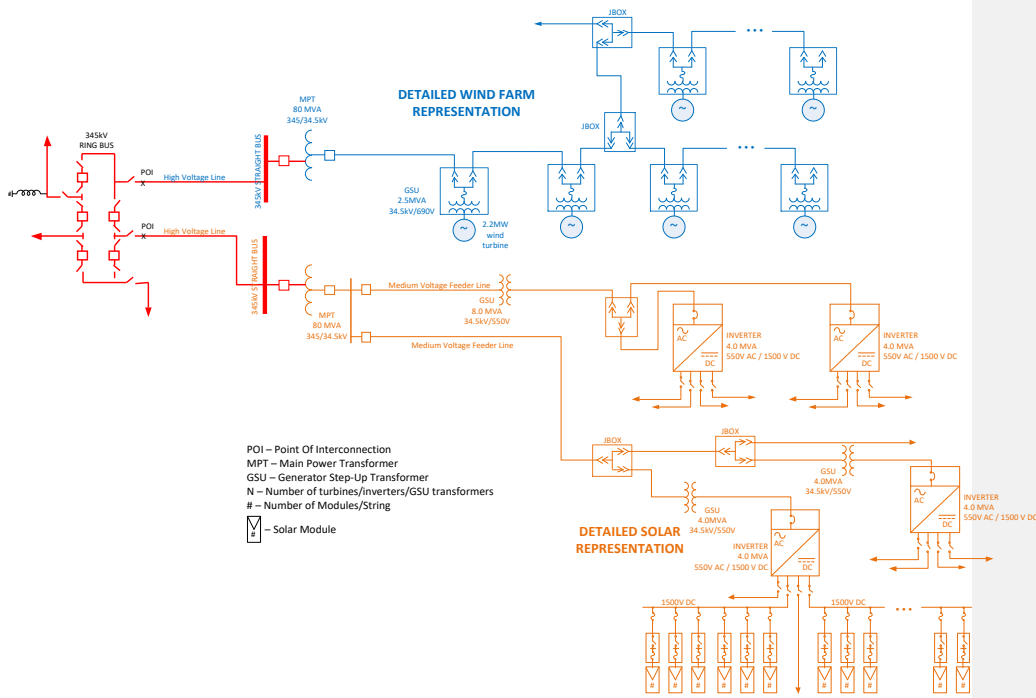
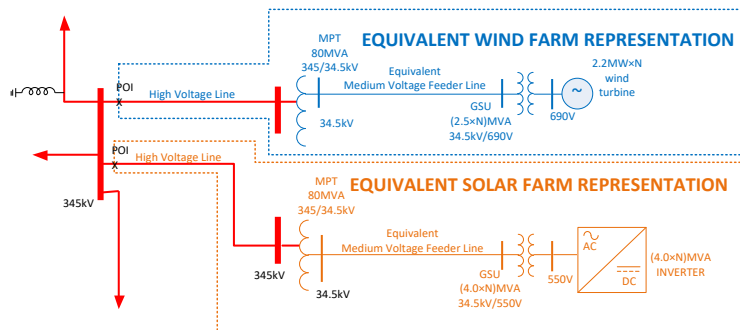

Figure 1: Detailed Wind and Solar Farm Representation (Not to be used for planning models)



POI – Point Of Interconnection
MPT – Main Power Transformer
GSU – Generator Step-Up Transformer
N – Number of turbines/inverters/GSU transformers

Figure 2: Equivalent Wind and Solar Farm Representation (Required representation for planning models)

Periodic Model Updates

After the annual update process is complete, it may become necessary to perform an update to the information contained in the model(s). Some of the reasons for updating the model(s) and the procedure for doing so are listed below.

System Impact Studies/Expansion Options Studies (Long-Term)

SPP performs transmission planning studies and assessments for various eligible customers. These model sets are developed in accordance with the SPP Planning Modeling Process and include models used for the SPP Transmission Expansion Plan, Transmission Service Studies, and Generation Interconnection Studies, which all use the data submitted to MOD as a base for model development.

MDWG Updates

At some point after the current models are extracted out of MOD some data will need to be updated to reflect pertinent changes to the system (i.e., lost or added transmission capability, lost or added generation, improved data, etc...) There are several ways of submitting changes to the steady-state models.

Two of these methods are:

1. Using the steady-state update procedure in Section 5 to update MOD.
2. Submitting a PTI, IDEV format file to perform the RDCH operation. **This method should only be used for profile changes. Each company should only submit one IDEV file per modeling pass. Under special circumstances topology changes can be submitted in an IDEV file as long as a MOD Project is submitted in MOD.**

It is imperative that any information submitted to SPP be error free and complete to avoid delays in the implementation of the changes.

The most current update to the models will always be posted on the SPP file sharing site.

Program Operation

The SPP steady-state models are created, modified, and maintained utilizing the Power Technologies, Incorporated (PTI) Power System Simulator for Engineers (PSS®E) software package. The PSS®E program is installed on SPP computer facilities located in Little Rock, Arkansas.

PTI-PSS®E Data Format

Steady-State data is input to the models from computer text data files structured in the formats described in the PSS®E Program Operation Manual Volume I, Chapter 4: Section 1.1. All data is read in "free format" with data fields separated by a **comma (not blanks)**. Each type of data category is terminated by the specification of a zero in the first field of the record with the exception of the model identification data.

Data is **added** to the SPP steady-state models as specified in these format structures for records where no corresponding component is found in the model. The **modification** of existing data in the model is accomplished using the same format structure, except that only the values that need modification are specified.

Data may also be deleted from the models. When a bus is specified for deletion, all associated data for that bus will be removed (e.g., branches, transformers, generators, and loads). **The user cannot delete a piece of equipment and then add it with new data. For example, to upgrade a bus from one voltage to another, the bus data must be modified.** Data currently in the model is used as the default value for data fields not specified in the format.

Steady-State Solution

The steady-state solution will have “Area interchange control” with the “Tie Line and Loads” option selected to meet ERAG MMWG model building requirements.

The SPP transaction workbook must not include transactions for sales to loads in other control areas if the loads are specifically identified with source control area number. If the loads in an external control area are not identified with the source control area’s number, then a transaction is necessary to schedule to this load. See example below for more details for a load that Source Area XXX has the obligation to serve:

No Transaction Needed

Source Area: XXX
Sink Area: YYY
Sink Load: XXX

Transaction Needed

Source Area: XXX
Sink Area: YYY
Sink Load: YYY

Loads may be modeled on the foreign area bus as long as it is identified as belonging to the owning area.

SPP will identify remote SPP loads in the base cases, pass 1, pass 2, and pass 3 models.

TRANSMITTED DATA FILE EXAMPLES (Refer to MOD Procedure Manual)

PTI-PSS@E SHORT CIRCUIT DATA FORMAT

The SPP Short Circuit data is included in MOD Base Case (Network) and Project data. The sequence data is comprised of positive, zero, and negative sequence data. Short circuit data that is missing in the MOD Base Case must be entered in MOD via a MOD Project with the Project Type of Network and Project Status of Update. Missing Project sequence data must be updated by applying a sequence file to the Project in MOD.

The PC (SPP) prior to presenting short circuit models to the MDWG for approval shall verify that all submitted member data has been correctly added to the short circuit models. The short circuit models shall be checked for errors and validated as usable by the PC. Any errors in the sequence data shall be brought to the attention of the Data Submitter. The usability checks shall include the PC performing data checks for missing sequence data and testing of models. The test of the models shall consist of fault analysis for three-phase, single-line-to-ground, and double-line-to-ground. The testing of the models is to ensure the models are ready for fault analysis by the SPP membership and absent of modeling errors.

For GSUs that are not retired with the associated generator, the appropriate status should be reflected in the model in order to produce accurate short circuit results.

Member submitted sequence via an IDEV file applied to a model will not be included in the next published model (Pass N or Final). The reason that sequence data is not carried over from one model set to the next model set is that sequence data is exported from MOD. Post MOD model processing IDEV files are not applied to the next model set; therefore, a MOD project which includes the sequence data must be submitted to MOD and accepted before it is included in the next MOD exported model.

SPP Data

Typical Transmission Line or Transformer Impedance

These tables are only for the checking of reasonableness of line and transformer data and should not be used in data preparation for existing facilities.

Typical Transmission Line Data

(100 MVA BASE)

kV	Amps	R/mile	X/mile	(Mvar/mile) Charging	MVA	X/R
69	600	0.00540	.0143	0.00030	71	2.6
115	1200	0.00064	.0050	0.00084	240	7.8
138	1200	0.00045	.0038	0.00120	296	8.4
161	2000	0.00020	.0019	0.00220	558	9.5
230	2000	0.00010	.0010	0.0040	796	10
345	2000	0.00004	.00048	0.0091	1195	12
500	2000	0.00002	.00026	0.0170	1732	13

A typical transmission transformer's impedance is approximately 8% on the OA rating base.

For example:

On a 345 kV Line that is 70 miles long—

R is: $70(0.00004) = 0.0028$

X is: $70(0.00048) = 0.0336$

Charging is: $70(0.0091) = 0.637$

Formatted: Highlight

Commented [MO1]: Each entity's standards can be different and it could cause confusion / introduce risk.

Formatted: Highlight

Formatted: Highlight

Formatted: Highlight

Formatted: Highlight

Formatted: Highlight

Formatted: Highlight

Formatted: Highlight

Formatted: Highlight

Formatted: Highlight

Formatted: Highlight

System Abbreviations & Area Number Assignments

System Abbreviations & Area Number Assignments can be found on SPP's website, spp.org, under the documents section of the Model Development Working Group.

SPP Members

The SPP Members are identified on the SPP Website. See the "Members" link under "About SPP" on www.SPP.org.

FORMS – Area Summary Report



Area Name & Number: _____
Prepared By: _____
Telephone Number: _____

POWER FLOW DATA AREA SUMMARY REPORT														
CASE														
1. Generation														
Purchases (-)/Sales (+)														
To/From Area Name														
2. Total Interchange														
3. Net Power (1-2)														
4. Load														
5. Losses														
6. Net Load (4+5)														
7. Slack Bus Generation														
8. Slack Bus Number & Name														
Note:														

FORMS – Steady-State Data Checklist

													Area Name & Number: _____ Prepared By: _____ Telephone Number: _____		
POWER FLOW DATA CHECKLIST															
CASE															
BUS DATA	X	X	X	X	X	X	X	X	X	X	X	X	X	X	X
Names - 12 characters															
Voltage Codes															
Power Factor															
Load - Real															
Reactive Load															
Voltage															
Fixed Shunts - Reactors															
Capacitors															
Dynamic Shunts - SVC's															
Synchronous Condensers															
Generation - Dispatch/Net															
Reactive Output															
Reactive Limits															
Regulated Voltages															
Generator Rating															
Slack Bus															
LINE DATA	X	X	X	X	X	X	X	X	X	X	X	X	X	X	X
Ratings - Normal															
Emergency															
Impedance - Resistance															
Reactance															
Charging															
Flows															
Transformers - Taps															
Tap Ranges															
Regulated Bus															
OTHER DATA	X	X	X	X	X	X	X	X	X	X	X	X	X	X	X
Net Area Interchange															
Area Transactions															
Note:															

ACRONYMS

ATC – Available Transfer Capability
CAP – Capacitor
EIA – Energy Information Act
ERAG – Eastern Interconnection Reliability Assessment Group
ERCOT – Electric Reliability Council of Texas
FPC – Federal Power Commission
IDEV – Input Device (PSS@E Dialog Input Device Selection Activity)
LTC – Load Tap Changing
MAPP – Mid-Continent Area Power Pool
MAIN – Mid-American Interpool Network
MBASE – Machine Base
MDWG – Model Development Working Group
MMWG – Multiregional Modeling Working Group
Mvar – Megavar
MW – Megawatt
NERC – North American Electric Reliability Corporation
PSS@E – Power System Simulator for Engineers
PTI – Power Technologies, Inc.
pu – Per-unit
RAWD – Raw Data
RDCH – Read Change (Command to read in and change data in PSS@E)
REAC – Reactor
SERC – Southeastern Electric Reliability Council
SPP – Southwest Power Pool, Inc.
STEP - SPP Transmission Expansion Plan
TWG – Transmission Working Group
WSCC – Western Systems Coordinating Council
ZSOURCE – Zero Impedance

NOTE – A complete listing of other SPP acronyms can be found on the SPP website at www.spp.org.
See the “Glossary and Acronyms” link under “Training”

MDWG Contact List

The MDWG Contact List can be found on SPP's website, spp.org, under the documents section of the Model Development Working Group.

SPP Model Release Guidelines

Steady-State and Short Circuit Models

SPP Base Case steady-state models and short circuit models are available to all SPP members. SPP and its members, by participating in SPP base case development, grant authority to the other participating members and SPP to release SPP Base Case steady-state models or reduced network equivalents of those models to government agencies. The public may receive models by filling out a SPP models order form and signing the appropriate SPP Confidentiality Agreement. For more information on requesting Base Case steady-state models, contact the SPP Model Contact.

Base case steady-state models of external systems, which are beyond the electrical borders of SPP and released under FERC Form 715 to government agencies, shall be the SPP models or a reduced network equivalent of the SPP models. If equivalized, such external models must be disclaimed, as equivalent representations not intended for study of the transmission systems in those external areas.

System Dynamic Data Base and Dynamic Simulation Cases

SPP Dynamic Base Case Models are available to all SPP members. SPP and its members, by participating in MMWG dynamics database (SDDB) and dynamics simulation case development, grant authority to the other participating Regions, to receive and use the SDDB and dynamics simulation cases. Regional members may send dynamics simulation cases or dynamics data to third parties provided that the third party executes a SPP confidentiality/non-disclosure agreement. The MMWG Dynamics Database (SDDB) remains the property of and is for the sole use of the MMWG participating Regions of NERC and their members.

SPP Model ~~contact~~ **Contact:**

Please send all general modeling questions and concerns to SPEngineeringModeling@spp.org.

Commented [SR2]: Based on SPP-Legal Feedback capitalized "C" in "Contact" since posting background material

Formatted: Default Paragraph Font

Request an SPP Map / Model

~~You may request an SPP Transmission Map/Model through the Request Management System by clicking on the "Order Transmission Map/Model" quick pick option.~~

Commented [SR3]: Based on SPP-Legal Feedback changed "a" to "an" since posting background material

~~Questions? You may find it helpful to consult SPP Maps & Models FAQ.
Questions? You may find it helpful to consult SPP Maps & Models FAQ.~~

~~If you are an SPP member, interconnection customer, transmission service customer (or their consultant) and would like to request an SPP Transmission Map or Model, please complete the appropriate forms below. (Requests for Joint & Interregional System Planning Models are addressed on [this page](#).) If you are requesting access on behalf of an organization other than your employer, a Consultant Authorization Form must also be submitted on your behalf.~~

~~[SPP Transmission Map Order Form](#)~~

~~[SPP Model Order Form](#)~~

~~[SPP Confidentiality Agreement](#)~~

Consultant Authorization Form

All other requesters should file a Critical Energy Infrastructure Information (CEII) request with the Federal Energy Regulatory Commission (FERC). Detailed instructions on how to file a FERC CEII request are available at www.ferc.gov/help/filing_guide/ceii_request.asp. You may file your CEII request online at www.ferc.gov/legal/ceii-foia/ceii/eceii.asp.

If you have obtained FERC CEII approval and would like to request additional CEII, please submit the appropriate SPP Form(s) and SPP Confidentiality Agreement, **providing the requester's FERC CEII ID Number and attaching a copy of the FERC Authorization Letter (i.e., FERC Notice of Intent to Release).**

Completed SPP Forms and the SPP Confidentiality Agreement should be e-mailed to SPP Customer Relations. The original, signed hardcopy of the SPP Confidentiality Agreement should be mailed to the attention of **Susan Polk, 201 Worthen Drive, Little Rock, Arkansas 72223**.

If you have questions or would like additional assistance, please contact SPP Customer Relations at (501) 614-3309.

Last Updated June/July 30/26, 2015/2018

MDWG Case Type Set

The current MDWG Case Type Set can be found on SPP's website, spp.org, under the documents section of the Model Development Working Group.

Error Screening

The following data error screening checks will be used to check case quality:

1. Interchange and tie line data not matching the raw data will not be accepted until either the interchange data or the raw data are corrected. *
2. All CNTB errors shall be corrected. (Exceptions will be documented.)
3. All instances of mode=1 switched shunts with VHI - VLO < .005 per unit shall be corrected.
4. Any regulation by any regulating device of a bus more than one bus away, except where there is a three-winding transformer in which case no more than two buses away, shall be corrected.
5. All instances of TCUL transformers with more than 50 tap steps shall be corrected.
6. All instances of voltage controlling bandwidth less than twice the transformer tap step size shall be corrected.
7. All transmission lines 69 kV and above, transformers with a secondary voltage of 69 kV and above, and Generator Step Up (GSU) transformers shall not have overloads (loading above 100% of Rate A) in the base case. Exception: 10 year cases may have overloads.

The effect of this check will be to delay acceptance of the applicable submittal until the problem is corrected.

Dynamics Data Submittal Requirements and Guidelines

Steady-State Modeling Requirements

1. All steady-state generators, including synchronous condensers and Static VAR Compensators (SVCs) modeled as generators, shall be identified by a bus name and unit id. All other dynamic devices, such as switched shunts, relays, and HVDC terminals, shall be identified by a bus name and base kV field. The bus name shall consist of eight characters and shall be unique within the Eastern Interconnection. Any changes to these identifiers shall be minimized.
2. Where the step-up transformer of a synchronous or induction generator or synchronous condenser is not represented as a transformer branch in the steady-state cases, the step-up transformer shall be represented in the steady-state generator data record. Where the

step-up transformer of the generator or condenser is represented as a branch in the steady-state cases, the step-up transformer impedance data fields in the steady-state generator data record shall be zero and the tap ratio unity. The mode of step-up transformer representation, whether in the steady-state or the generator data record, shall be consistent from case to case within a model series.

3. Where the step-up transformer of a generator, condenser, or other dynamic device is represented in the steady-state generator data record, the resistance and reactance shall be given in per unit on the generator or dynamic device nameplate MVA. The tap ratio shall reflect the actual step-up transformer turns ratio considering the base kV of each winding and the base kV of the generator, condenser or dynamic device.
4. In accordance with PTI PSS@E requirements, the Xsource value in the steady-state generator data record shall be as follows:
 - a. Xsource = X''_d for detailed synchronous machine modeling
 - b. Xsource = X'_d for non-detailed synchronous machine modeling
 - c. Xsource = should be equal to locked rotor impedance for an induction machine
 - d. Xsource = 1.0 per unit or larger for all other devices
5. Generally, SVCs should be represented in steady-state as continuously variable switched shunts rather than as generators. In iterative steady-state solutions, a generator which hits a VAR limit on solution iteration will lock at that value, but a switched shunt will move off the limit in a subsequent iteration if appropriate. PSS@E dynamic library models compatible with either representation are available. If a user model representing particular SVC and control features is to be used and that model assumes generator representation, the SVC should be represented as a generator in the steady-state.

Dynamic Modeling Requirements

1. All synchronous generator and synchronous condenser modeling and associated data shall be detailed except as permitted below. Detailed generator models consist of at least two direct axis circuits and one quadrature axis equivalent circuit. The PSS@E dynamic model types classified as detailed are GENROU, GENSAL, GENROE, GENSAE, and GENDCO.
The use of non-detailed synchronous generator or condenser modeling shall be permitted for units with nameplate ratings less than or equal to 50 MVA under the following circumstances:
 - a. Detailed data is not available because manufacturer no longer in business.
 - b. Detailed data is not available because unit is older than 1970.The use of non-detailed synchronous generator or condenser modeling shall also be permitted for units of any nameplate rating under the following circumstances only:
 - a. Unit is a phantom or undesignated unit in a future year MMWG case.
 - b. Unit is on standby or mothballed and not carrying load in MMWG cases.The non-detailed PSS@E model types are GENCLS and GENTRA. When complete detailed data are not available, and the above circumstances do not apply, typical detailed data shall be used to the extent necessary to provide complete detailed modeling.
2. All synchronous generators and condensers modeled in detail per Requirement II.1 shall also include representations of the excitation system, turbine-governor, power system stabilizer, and reactive line drop compensating circuitry. The following exceptions apply:
 - a. Excitation system representation shall be omitted if unit is operated under manual excitation control.

- b. Turbine-governor representation shall be omitted for units that do not regulate frequency such as base load nuclear units, pumped storage units in pumping mode and synchronous condensers.
 - c. Power system stabilizer representation shall be omitted for units where such device is not installed or not in continuous operation.
 - d. Representation of reactive line drop compensation shall be omitted where such device is not installed or not in continuous operation.
3. All other types of generating units and dynamic devices including induction generators, static VAR compensators (SVC), high-voltage direct current (HVDC) systems, static compensators (STATCOM), wind turbines, and photovoltaic systems shall be represented by the appropriate PSS@E dynamic models.
4. All demand data shall include a load model which represents the expected dynamic behavior of the loads. Non-scalable loads greater than or equal to 10 MW are required to have a dynamic load model representation. For all other types of loads, absent detailed dynamic load models, the real portion (MW) of all demand data is converted to 100% constant current and the reactive portion (Mvar) of all demand data is converted to 100% constant admittance.
5. Standard PSS@E dynamic models shall be used for the representation of all generating units and other dynamic devices unless both of the following conditions apply:
 - a. The specific performance features of the user-defined modeling are necessary for proper representation and simulation of inter-regional dynamics, and
 - b. Standard PSS@E dynamic models cannot adequately approximate the specific performance features of the dynamic device being modeled.
6. When user-defined modeling is used, written documentation shall be supplied explaining the dynamic device performance characteristics. The documentation for all user-defined models shall be provided as a separate document and must include the characteristics of the model, including block diagrams, values and names of all model parameters, and a list of all state variables. Any benign warning messages that are generated by the model code at compilation time should also be documented.

Source code for User Models shall be submitted in the FLECS language of the current PSS@E revision, C, or FORTRAN. User models created in MATLAB/SIMULINK are not permitted because users of the SDDB cannot run them without purchase of additional software.
7. Netting of small generating units, synchronous condensers, or other dynamic devices with bus load shall be permitted only when the unit or device nameplate rating is less than or equal to 20 MVA. (Note: any unit or device which is already netted with bus load in the MMWG cases need not be represented by a dynamic model.)
8. Lumping of similar or identical generating units at the same plant shall be permitted only when the nameplate ratings of the units being lumped are less than or equal to 50 MVA. A lumped unit shall not exceed 300 MVA. Such lumping shall be consistent from case to case within a model series.
9. Where per unit data is required by a dynamic model, all such data shall be provided in per unit on the generator or device nameplate MVA rating as given in the steady-state generator data record. This requirement also applies to excitation system and turbine-governor models, the per unit data of which shall be provided on the nameplate MVA of the associated generator. The maximum and minimum power of

cross compound units should be provided on the nameplate MVA of one machine in accordance with PSS@E model IEEE1 conventions.

10. Exceptions will be approved by MMWG on a case by case basis and the reason for each exception will be documented in the SDDB.

Dynamics Data Validation Requirements

1. All dynamics modeling data shall be screened according to the SDDB data screening checks.
2. All data items not passing these screening tests shall be resolved with the generator or dynamic device owner and corrected.
3. All regional data submittals to the MMWG coordinator shall have previously undergone satisfactory initialization and 20-second no-disturbance simulation checks for each dynamics case to be developed. The procedures outlined in Section III.H* of this manual (*yet to be written) may be applied for this purpose.

Guidelines

1. Dynamics data submittals containing typical data should include documentation which identifies those models containing typical data. The CON conservation models, such as GENROA and GENSAA, which essentially copy dynamics data from one unit to another, may be useful for this purpose. When typical data is provided for existing devices, the additional documentation should give the equipment manufacturer, nameplate MVA and kV, and unit type (coal, nuclear, combustion turbine, hydro, etc.).
2. The voltage dependency of loads should be represented as a mixture of constant impedance, constant current, and constant power components (referred to as the ZIP model). The Regions should provide parameters for representing loads via the PTI PSS@E CONL activity. These parameters may be specified by area, zone, or bus. Other types of load modeling should be provided to MMWG when it becomes evident that accurate representation of interregional dynamic performance requires it.

Procedures for Submission of Dynamics Data to the MMWG Coordinator

Regional Coordinators have two options, described below, for submitting dynamics data to the MMWG Coordinator.

Dynamics Data Updates Using Excel Template

Regional dynamics data updates are incremental to the dynamics data in the previous year release of SDDB. Regional Coordinators should therefore verify that bus names and unit IDs in SDDB are consistent with those in the MMWG steady-state to be made dynamics ready.

The table below describes the various types of updates and the required data and information that should be provided on the Excel template and in a separate DYRE file.

Type of Update	Template Entries	Complete DYRE format record	Examples / Comments
Change one or more parameters of a dynamics model	Bus name, unit ID, model name, parameter name, new value	No	The voltage regulator gain is changed to the value determined by test.
Add a new model to an existing unit	No	Yes	A stabilizer is being added to a unit which did not have one.
Delete a model	Bus name, unit ID, model name	No	A stabilizer is removed.
Replace a model with another model of the same equipment group	Bus name, unit ID, model name for deleted model.	Yes for new model.	1. A DC exciter is replaced by a static exciter. 2. A classical machine model is replaced by a detailed model.
Change bus name and/or unit ID for all models of an existing unit	Old and new names; old and new unit IDs	No	
Change bus number	No	No	Maintain the same name and unit ID and the model data will follow automatically.
Add dynamic models for a new generating unit	Bus name, unit ID, in service and out of service dates, MVA base, Zsource, RPM, unit type	Yes	Same requirements whether unit is at new or existing bus.
Remove a unit and all associated models	Bus name, unit ID	No	

Complete Set of Dynamics Data

The regional dynamics data must be in the format of a PSS@E DYRE file. The data must be compatible and consistent with the MMWG steady-state selected for the dynamics cases that are being developed. One file for all cases is preferable.

MMWG Deliverables

Regional Coordinators

The Regional Coordinators will provide the following to the MMWG Coordinator(s).

1. Steady-State Cases
 - a. Data as needed to create the MMWG steady-state cases in RAWD or Saved Case format, regional representation shall be within an entire solved MMWG steady-state model in the proper PSS@E revision format
 - b. Tieline and interchange data in the specified format
 - c. IDEV files for any data changes
 - d. PSS@E formatted contingency file containing five N-1 contingencies valid for all cases in the model series.
 - e. Data Dictionary containing fields for Bus Number, 18 character PSS@E Bus Name, EIA Plant Code (U.S. only) and Non-Abbreviated Bus Name.
2. Dynamics Cases
 - a. Dynamics input data in DYRE format for new models
 - b. SDDDB Excel worksheet for changes to the database
 - c. FLECS code and documentation for user defined models
 - d. Load conversion CONL file sorted by area
 - e. List of netted generation buses
 - f. Two contingency events per region in IDEV format

MMWG Coordinator(s)

The MMWG Coordinator(s) will post the following to the ERAG Web Site.

1. Steady-State Cases
 - Initialized steady state and regional contingency cases.
 - a. Steady-State RAWD case file
 - b. Conversion IDEV files
2. Dynamics Cases
 - Dynamics case input data, output files and instructions including:
 - a. Dynamics input data in DYRE format
 - b. FLECS code for user defined models
 - c. Load conversion CONL file sorted by area
 - d. Any IPLAN or PYTHON programs necessary to set up the dynamics case
3. Complete dynamics database and User Manual
4. Final reports

SECTION 2: STEADY-STATE MODELING

1. Modeling Detail – Each bus should be assigned the appropriate area, owner, and zone. All transmission lines 115 kV and above and all transformers with a secondary voltage of 115 kV and above should be modeled explicitly. Significant looped transmission less than 115 kV should also be modeled.
2. Nominal Bus Voltage – All bus voltages are expressed as a phase-to-phase voltage. All buses should have a non-zero nominal voltage. Nominal voltages of buses connected by lines, reactors, or series capacitors should be the same. The following nominal voltages are standard for AC transmission and sub-transmission in the United States and Canada and should generally be used: 765, 500, 345, 230, 161, 138, 115, 69, 46, 34.5 and 26.7 kV. In addition, significant networks exist in Canada having the following nominal voltages: 735, 315, 220, 120, 118.05, 110, 72, and 63.5 kV.
Nominal voltages of generator terminal and distribution buses less than 25 kV are at the discretion of the reporting entity.
If transformers having more than two windings are modeled with one or more equivalent center point buses and multiple branches, rather than as a 3-winding transformer model, it is recommended that the nominal voltage of center point buses be designated as 999 kV. Because this voltage is above the standard range of nominal voltages, it can easily be excluded from the range of data to be printed in steady-state output.
3. Islanded Buses – Islanded buses shall not be modeled.
4. Generator Modeling of Loads – Fictitious generators should not be used to “load net” (by showing negative generation) a model of other nonnative load imbedded in steady-state areas. It is recommended that a separate zone be used to model such loads to allow exclusion from system load calculations.
5. Zero Impedance Branches – Bus ties that are opened to represent switching during contingencies may be modeled in detail. Zero impedance branches are permitted to model bus ties using $R=0.00000 + X=0.0001$ and $B=0.00000$. These values facilitate differentiating between bus ties and other low impedance lines, utilizing the zero impedance threshold THRSZH in the PSS@E program. When connected between two voltage controlled (generator, switched shunt, or TCUL controlled), bus ties or other low impedance lines should be modeled using an impedance of $R=0.0001 + X=0.002$ and $B=0.00000$. This allows use of near-zero impedance attached to controlled buses that will be large enough to avoid significant solution problems.
6. Impedance of Branches In Network Equivalents – Where network representation has been equivalenced, a maximum cutoff impedance of 3.0 p.u. should be used.
7. Negative Branch Reactances – Except for series capacitors, negative branch reactances do not represent real devices. Their use in representing three winding transformers is obsolete. Negative branch reactances limit the selection of steady-state solution techniques and should be avoided.
8. Transformers – Effective with Revision 28 of PSS@E, off-nominal turns ratios may not be specified for branches; a block of four or five data records must be entered for each transformer. The off-nominal turns ratio in per unit, or the actual winding voltage in kilovolts, and the phase shift in degrees shall be specified for each winding. The measured impedance (resistive and inductive) between each pair of windings shall be specified: data entry options permit these to be entered in (1) per unit on system (100 MVA) base, (2) per unit on winding MVA base, or (3) load loss in watts and impedance on winding MVA base and base voltage.

9. Transformers Controlling Voltage or Reactive Power Flow – The upper and lower limits of off-nominal turns ratio and the number of tap positions available are entered for winding 1 of transformers controlling voltage or reactive power flow. Default values of 1.1, 0.9 and 33 are representative of U.S. practice. The upper and lower voltage limits are entered for transformers controlling voltage and the difference, in per unit, should be at least twice the tap step size. The upper and lower MVAR limits are entered for transformers controlling reactive power flow and these limits should differ by at least 10 MVAR. Limits should accurately represent the actual operation of automatic control devices.
10. Remote Regulation – Regulation of a bus voltage more than one bus away (not counting hidden center point buses of three winding transformers) from the regulating device should be avoided. The sign of parameter CONT determines whether the off-nominal turns ratio is increased or decreased to increase voltage at the bus whose voltage is controlled by this transformer.
11. Phase Shifting Transformers (PSTs) – Manufacturer tested capability and operational limits must be provided to SPP in order to allow corrective actions to be developed by SPP planning staff for transmission planning purposes.
PSTs will be represented in the planning models as Two-winding transformers with both windings at the same nominal voltage level. The active power flow into winding 1 is entered. The tolerance should be no less than 5 MW; i.e., a 10 MW dead band. The controlling band should be at least 10 degrees. The following characteristics should be considered by the entity submitting PST modeling data for the planning models:
 - a. Real-time operational auto or manual adjustment operation of the PST.
 - b. Real-time operational average MW flow for a particular season (e.g. average hourly MW flow is +18MW [directional based] during the Summer Peak Season, June 1 – September 30) in order to represent what is typically flowing through the PST during a particular season. This applies to PSTs that are not modeled for auto adjustment, in order to appropriately model the phase shift angle and relative MW flow, but should also consider the capability of the transformer regardless of the type of operation.
 - c. Real-time operational MW flow limits (e.g. ± 20 MW).
 - d. Real-time operational phase shift angle range (e.g. -52.9° to 31.4°).
 - e. The applicable planning model impedance table should reflect the impedance correction adjustments as the phase shift angle moves through the various angle steps.
 - f. Applicable long-term firm transmission service levels for the PST.
12. Branch and Transformer Ratings – Normal is defined as continuous ratings for system intact conditions and emergency is defined as limited duration ratings used until the system is returned to normal. Accurate normal and emergency seasonal ratings of facilities are necessary to permit proper assessment of facility loading in regional and interregional studies. Three rating fields are provided for each branch and each transformer winding. Normal and emergency ratings should be entered in the first two fields (RATEA and RATEB, respectively); use of the third rating field (RATEC) is optional. Ratings should be omitted for model elements which are part of an electrical equivalent. The rating of a branch or transformer winding should not exceed the rating of the most limiting series element in the circuit, including terminal connections and associated equipment. The emergency rating should be greater than or equal to the normal rating.
13. Generator Step-Up Transformers (GSU) – When modeled implicitly, the GSU Resistance, reactance and tap setting (all in per unit values) shall be provided along with the Generator data. Whenever modeled explicitly, a GSU shall be modeled similar to a power transformer and the GSU nominal winding voltages, impedance(s), tap ratios, minimum and maximum tap position limits, number of tap positions, regulated bus (as applicable), normal and emergency ratings and in-service status data shall be provided. GSUs may be modeled

- explicitly as deemed necessary by either the transmission owner or the Regional Reliability Organization. Their modeling should be consistent with the associated dynamics modeling of the generator. Generator step-up transformers of cross-compound units should be modeled explicitly.
14. Out-of-Service Generator Modeling – Out-of-service generators should be modeled with a STATUS equal to zero.
 15. Generator MW Limits – The generation capability limits specified for generators (P_{MIN} and P_{MAX}) should represent realistic seasonal unit output capability for the generator in that given base case. P_{MAX} should always be greater than or equal to P_{MIN}. Net maximum and minimum unit output capabilities should be used unless the generator terminal bus is explicitly modeled, the generator step up transformer is modeled as a branch, and unit load is modeled at the bus or buses from which it is supplied.
 16. Generator MVAR Limits – The MVAR limits specified for generators (Q_{MIN} and (Q_{MAX}) should represent realistic net unit output capability of the generator modeled. Q_{MAX} should always be greater than or equal to Q_{MIN}. Net maximum and minimum unit output capabilities should be given unless the generator terminal bus is explicitly modeled, the generator step up transformer is modeled as a branch, and unit load is modeled at the bus or buses from which it is supplied.
 17. Small Generators, Capacitors, and Static VAR Devices – Small generators (e.g., 10 MVA), small capacitors, and small SVCs have limited reactive capability and cannot effectively regulate transmission bus voltage. Modeling them as regulating increases solution time. Consideration should be given to modeling them as non-regulating by specifying equal values for Q_{MIN} and Q_{MAX}. If several similar machines or devices are located at a bus and there is a need to regulate with these units, they should be lumped into an equivalent to speed solution.
 18. Coordination of Regulating Devices – Multiple regulating devices (generators, switched shunt devices, tap changers, etc.) controlling the bus voltage at a single bus, or multiple buses connected by Zero Impedance Lines as described above, should have their scheduled voltage and voltage control ranges coordinated.
Also, regulated bus voltage schedules should be coordinated with the schedules of adjacent buses. Coordination is inadequate if solving the same model with and without enforcing machine regulating limits causes offsetting MVAR output changes greater than 500 MVAR at machines connected no more than two buses away.
 19. Over and Under Voltage Regulation – Regulation of voltage schedules exceeding 1.10 per unit, or below 0.90 per unit should be avoided.
 20. Flowgates – All transmission elements comprising part of one or more flowgates should be included in the data submitted by each region. A flowgate is a selected transmission element or group of elements acting as proxy for the transmission network representing potential thermal, voltage stability, rotor angle stability, and contractual system constraints to power transfer.
 21. Fixed Shunts – All fixed shunt elements at buses modeled in the steady-state should be modeled explicitly (not as loads or included with load). The status should be set to zero if the shunt is not in service. Fixed shunt elements that are directly connected to a bus should be represented as bus shunts. Fixed shunt elements that are directly connected to and switch with a branch should be represented as line shunts.
 22. Switched Shunts – Switched shunt elements at buses modeled in the steady-state should be modeled explicitly. Continuous mode modeling using a switched shunt should not be used unless it represents actual equipment (e.g. SVC or induction regulator). The number and size of switched admittance blocks should represent field conditions. The bandwidth (difference between V_{SWHI} and V_{SWLO}) of switched shunt devices should be wide enough

that switching one block of admittance does not move the voltage at the bus completely through the bandwidth, thus causing solution problems at the bus. It is recommended that the minimum voltage bandwidth be 4% if only switched shunts are used to regulate voltage. Switched shunts should not regulate voltage at a generator bus, nor should they be connected to the network with a zero impedance tie.

23. Static Var Systems – Static var elements should be modeled with accurate reactive power (leading/lagging) limits. An accurate voltage set point and equipment status, as well as any associated fixed/switched shunt equipment should also be modeled based on actual seasonal operation.
24. HVDC – All HVDC transmission facilities must be represented with a sufficiently detailed model to simulate its expected behavior.
25. Interchange Tolerances – In a solved case, the actual interchange for any area containing a Type 3 (swing) bus should be within 25 MW of the specified desired interchange value. (Note that PSS@E does not enforce the interchange deviation for areas containing Type 3 buses.)
26. Scheduled Interchange vs. Scheduled Tie Line Flows – Scheduled interchange between areas directly connected solely by ties with flows controlled to a specific schedule (PAR-controlled AC or DC) should be consistent with the PAR or DC scheduled flows.

Causes of Non-convergence and Problems in Merged Base Case Models

Causes of Non-convergence

1. A line whose impedance is very small as compared to that of a line connected in series with it.
(Solution: If possible, add impedance of short and long series-connected lines and represent as one line.)
2. Tie lines are missing because they were not picked up by model creation or tie lines are connected incorrectly.
3. An impedance or susceptance value whose magnitude is extremely large. A decimal point may have been misplaced, or large cutoff impedance was specified during equivalencing.
4. A system's regulating (slack) bus is in a different system. This is probably due to an incorrect data entry in changing a model.
5. An isolated system (island) has been inadvertently created. Voltage phase divergence will be flagged immediately and the program will stop calculating after the first iteration.
6. Unrealistic tap changing transformer tap limits.
7. Radial system is very large.
8. Poor voltage regulation such as:
 - a. Unequal voltage schedules at generating units connected by a low impedance line.
 - b. Regulation of a radial line at both ends at unequal voltages.
 - c. (Solution: Do not regulate a radial bus; hold MVAR output of a radial bus constant at the value obtained in last iteration.)
 - d. Conflicting voltage regulation.
 - e. Unreasonably small voltage range for switched shunts.
 - f. Remote regulation of more than one bus away.
9. Over-equivalencing of outside Regions in regional base case models.
10. Not solvable from flat start.
11. Fictitious regulation of buses.
12. Extremely low voltage schedules.

13. Not following the approved MMWG sign convention for phase shifters (see page 3 of this **Appendix**) or not adhering to minimum MW tolerance for phase-shifting-under load transformers.
14. Zero or very low reactance branches. Minimum reactance = 0.0001 per unit.
15. Inconsistent representation of delta-wye transformers, typically by two companies interconnected at both voltage levels.

Problems

1. Duplicate bus names in an area(s).
2. The data will not permit steady-state calculations, such as:
 - a. Zero voltage regulation, resulting in division by zero. Notify Regional Coordinator.
 - b. Interchange does not net to zero. Save the data but do not calculate until the Coordinator has given instructions for correcting the data.
 - c. High R/X ratios in equivalent area causing non-convergence. Delete line or reduce ratio.
3. Missing tie lines. These tie lines may or may not be in the base case model. The program flags the tie lines as missing because of its tie line checking routine. A review of the data dump will verify the inclusion of a tie line if it is included and has been flagged as missing. Likewise, the validity of the error message will be verified by a review of the data dump.
4. Phase Shifting Transformers
 - a. The first-named bus in the branch data is taken as the "From" bus and the second-named bus is taken as the "To" bus. The "From" bus is also taken as the tapped bus.
 - b. If phase shift angle is specified in CDF as positive, $\theta_A < \theta_B$.
 - c. Assuming θ_A and θ_B stay relatively constant for small changes, an increase in this positive phase shift angle will tend to change the voltage phase angle of Bus A in a lagging direction relative to that for Bus B. This causes an incremental increase in real power flow in the direction of B to C regardless of the direction of the initial real power flowing through the transformer.
 - d. A desired positive real power flow into the phase shifting transformer at the "From" bus or tapped bus is specified with positive real power limits.
 - e. The "Controlled Bus" specified should be the same as the tapped bus to be consistent and avoid confusion.

Note: The PTI PSS@E steady-state program currently being used by AEP to process MMWG models requires the above convention. Therefore, it is desirable that all phase shifter models sent to AEP conform to this convention. If the data submitted does not conform to the above convention, AEP must be notified so that appropriate corrections can be made.

SECTION: PROCEDURES FOR INITIALIZATION AND NO-DISTURBANCE CHECKS OF LIBRARY DYNAMICS CASES

Note: PSS@E activities relevant to the following steps are shown in brackets.

1. Create a converged load flow case with as few limit violations and questionable data items as possible.
 - a. Solve the case after each set of major changes [FNLS, FDNS, SOLV, or MSLV] and save it to minimize rework if a change has unintended consequences. If all of the following constraints are satisfied, convergence within tolerance, even from a flat start, should not take more than the default number of iterations. However, there is usually no reason to use a flat start if the case being updated was solved.
 - b. Generator checks using a list of all data to spot unrealistic, typically default, generator data values. [LIST, option 5] There is no checking activity listing only machines having suspect values of the following
 - i. Machine MVA on the default base of 100. Although models will work if all load flow and dynamic model parameters are entered on this basis, limit checks will not work correctly.
 - ii. Source impedance of 1.0 p.u. on machine MVA base. This value is substantially higher than normal for synchronous machines.
 - iii. Source impedances equal to or less than zero. These will cause generator conversion to fail.
 - iv. Real and/or reactive power limits of +9999 or -9999.
 - c. Checks which report abnormal values
 - i. Branch flows exceeding normal ratings. [RATE or OLTL and OLTR]
 - ii. Bus voltages below 0.95 p.u. except in the case of generator terminal voltage buses connected to the transmission bus by a step-up transformer with a tap ratio significantly off nominal. [VCHK]
 - iii. Overloaded generators. [GEOL]. Note that this activity checks machine output against the machine MVA base, MBASE, not against PMAX, PMIN, QMAX, and QMIN.
 - iv. Branches with extreme impedances or tap ratios [BRCH]. Suggested options are:
 - a) Small impedance. Note that very small impedances can be treated as zero impedance ties by selection of parameter THRSZ and these will not be a problem.
 - b) Negative reactance. These are typically found in Y representations of three winding transformers. Solution activity SOLV may not be used on cases containing such branches and MSLV may not be used if they are present at a Type 2 or 3 (generator) bus.
 - c) Charging. Values exceeding the default upper check limit (5.0 p.u.) are normal on long EHV lines but others should be checked. Negative values are occasionally used for magnetizing impedance on transformers but this usage is not recognized in the PSS@E Program Operation Manual.

- d) Parallel transformers. Minor tap ratio differences may simply reflect field conditions, but differences exceeding one step should be checked to guard against inadvertent errors.
 - e) High tap ratios.
 - f) Low tap ratios.
 - d. Interactive checks: the user is asked to enter new value(s) for each exception, or hit "carriage return" for no change.
 - i. Generators dispatched outside their real power limits [SCAL]. Scaling areas or zones should be used cautiously if generators having default PMAX (+9999) and PMIN (-9999) limits are present.
 - ii. Inconsistent targets at a bus whose voltage is controlled by two or more system elements: local generation, switched shunts, and voltage controlling transformers. [CNTB]. There is a tendency not to recognize different summer and winter operating strategies where appropriate.
 - iii. Questionable voltage or flow controlling transformer parameters. [TPCH]
 - iv. Buses in "islands" not containing a system swing bus. [TREE]. Note that there can be multiple islands each of which does contain a system swing bus, with DC links connecting them.
 2. To confine the initialization to a subset of the original load flow, for instance the areas comprising one region, proceed as follows.
 - a. Create a raw data file containing only the area(s) of interest. [RAWD, AREA]
 - b. Read in the raw data file just created. [READ]
 - c. If no system swing bus is in the area kept, change the type of a generator bus from 2 to 3 to make it the system swing bus. [CHNG]
 - d. Locate any islands created by the subsetting operation and either connect or drop them. [TREE].
 - e. Replace flows on tie lines severed by the subsetting operation with equivalent loads (positive for flows out, negative for flows in). [BGEN]
 3. Net generation with load at any buses where a generator(s) exists for which no dynamic models are available. [GNET].
 4. Convert the generators in the load flow [CONG], solve, [ORDR, FACT, TYSL] and save converted case.[SAVE]
 5. From the dynamics entry point, read in the dynamic model data file [DYRE] (Load flow case must also be in memory.)
 - a. Specify CONEC, CONET, and COMPILE files.
 - b. It is highly desirable to include a SYSANG model in the DYRE file, although this makes it mandatory to recompile even if no user models are included. This model provides six monitoring output channels, which can be used to scan a no-disturbance simulation for stability without attempting to select individual machines to monitor.
 6. Concatenate FLECS code for user models onto CONEC or CONET files.
 7. Compile.
 8. Execute CLOAD4.
 9. Restart from the dynamics entry point, this time using "user dynamics".
 - a. Read converted load flow [CASE].
 - b. Read in the dynamic data file [DYRE]
 - c. Specify channels to record appropriate states and variables as simulation outputs [CHAN]. Include SYSANG variables if this model was included in the dynamics data file as suggested above.
 - d. Check consistency of dynamic models [DYCH, option 1].

- e. Initialize dynamic simulation [STRT]. The output of this activity may have several important parts and it is desirable to keep a log file for reference while debugging.
 - i. Warning messages for
 - a) Generators in the load flow for which there is no active machine model.
 - b) Models, usually of excitation systems or governors, initialized out of limits.
 - c) The number of iterations required to initialize the initial-conditions steady-state.
 - ii. A tabulation of conditions at each online machine
 - a) Terminal voltage
 - b) Exciter output voltage
 - c) Real and reactive power output
 - d) Power factor
 - e) Machine angle in degrees
 - f) Direct and quadrature axis currents on machine base.
 - iii. A diagnosis of initial conditions, either
 - a) "Initial conditions check OK", or
 - b) A listing of suspect initial conditions generally states whose time derivative is not "small" (relative to the value of the state). These may be caused by inconsistencies between the real and reactive power scheduled for a unit by the load flow (including automatic changes in reactive power to hold bus voltage at a target level) or by parameter errors.
 - iv. For models flagged in steps i) through iii), consider using activity [DOCU] to identify parameters which may be causing problems. This activity will also give the automatically calculated values of exciter model parameters, which are derived if the corresponding parameters, as read in, are 0. Other warnings may indicate errors in the steady-state model.
 - f. Modify model parameters or the load flow as appropriate and repeat steps up to this point until there are no warning messages nor suspect initial conditions.
10. Record a snapshot [SNAP] of dynamic state values prior to application of any disturbance or simulation of any time period.
 11. Simulate undisturbed operation [RUN] for at least 20 seconds. Printing the convergence monitor [RUN,CM] can indicate where problems are, but considerably increases the amount of output.
 12. Stop simulation. Review output values in tabular and/or graphical form.
 13. Validate exciter model response to a step change in set point. [ESTR] and [ERUN]. Field voltage and terminal voltage will be output for each exciter model and may be reviewed in tabular or graphical form. Satisfactory response is indicated if the terminal voltage settles to the specified value within a few seconds, if the field voltage is reasonable, and the response is free of
 - a. Excessive overshoot
 - b. Sustained oscillations
 - c. High frequency noise (may be caused by using too long a simulation time step.)
 - d. Unexpected discontinuities in the output variables or their derivatives (except IEEE Type 4 "non-continuous" regulator models).
 14. Validate governor model response to a step change. [GSTR] and [GRUN]. Mechanical power and speed deviation will be output for each shaft where a governor model is present and may be reviewed in tabular or graphical form. Models of cross-compound unit governors specify two machines so four output variables are used. Steam or combustion turbine unit governors may require up to 20 seconds to attain

equilibrium, and hydro units even longer, even if they are well tuned. Satisfactory response is indicated if speed deviation settles to approximately $(-K) = (-1/R)$, mechanical power to $(1-1/K)$ times the specified value, and the response variables are free of excessive overshoot or sustained oscillations.

Compliance

1. MDWG [Model Development Procedure Manual](#)
Note: The latest document can be found on SPP.org
2. MDWG [Power flow, Short Circuit, and Dynamic model schedule and list](#)
Note: The latest document can be found on SPP.org
3. Data Submittal Forms (This is a separate document)
Note: The latest document is posted with every model set
4. MDWG Procedure for late or no data submittal (FUTURE)

SECTION: APPENDIX I MASTER TIE LINE FILE DATA FIELDS

Branch Data Fields

In Service Date,
Out Service Date,
From Region Name,
From Area#,
From Area Name,
From Bus#,
From Bus Name,
From Bus kV,
To Region Name,
To Area#,
To Area Name,
To Bus#,
To Bus Name,
To Bus kV,
Metered End (F,T),
CKT,
R,
X,
B,
Summer Rating A,
Summer Rating B,
Summer Rating C,
Winter Rating A,
Winter Rating B,
Winter Rating C,
GI (pu),
BI (pu),
GJ (pu),
BJ (pu),
STATUS (0,1),
LEN (mi),
Owner 1,
Fraction 1,
Owner 2,
Fraction 2,
Owner 3,
Fraction 3,
Owner 4,
Fraction 4

Two Winding Transformer Data Fields

In Service Date,
Out Service Date,
From Bus Region Name,
From Bus Area#,
From Bus Area Name,
From Bus Number,
From Bus Name,
From Bus kV,
To Bus Region Name,
To Bus Area#,
To Bus Area Name,
To Bus Number,
To Bus Name,
To Bus kV,
Tapped Side,
CKT,
CW,
CZ,
CM,
MAG1,
MAG2,
Metered Side,
NAME,
STATUS (0,1),
Owner 1,
Fraction 1,
Owner 2,
Fraction 2,
Owner 3,
Fraction 3,
Owner 4,
Fraction 4,
R1-2,
X1-2,
SBase1-2,
WindV1,
NomV1,
Ang1,
Summer Rating A1,
Summer Rating B1,
Summer Rating C1,
Winter Rating A1,
Winter Rating B1,
Winter Rating C1,

Two Winding Transformer Data Fields - continued

COD1,
Volt Control Bus Region Name,
Volt Control Bus Area Number,
Volt Control Bus Area Name,
Volt Control Bus Number (CONT1),
Volt Control Bus Name,
Volt Control Bus kV,
RMA1,
RMI1,
VMA1,
VMI1,
NTP1,
TAB1,
CR1,
CX1,
WindV2,
NomV2

Three Winding Transformer Data Fields

In Service Date,
Out Service Date,
Winding 1 Region Name,
Winding 1 Area#,
Winding 1 Area Name,
Winding 1 Bus#,
Winding 1 Bus Name,
Winding 1 Bus kV,
Winding 2 Region Name,
Winding 2 Area#,
Winding 2 Area Name,
Winding 2 Bus#,
Winding 2 Bus Name,
Winding 2 Bus kV,
Winding 3 Region Name,
Winding 3 Area#,
Winding 3 Area Name,
Winding 3 Bus#,
Winding 3 Bus Name,
Winding 3 Bus kV,
CKT,
CW,
CZ,
CM,
MAG1,
MAG2,
NMETR(1,2,3),
NAME,
STATUS(0,1),
Owner 1,
Fraction 1,
Owner 2,
Fraction 2,
Owner 3,
Fraction 3,
Owner 4,
Fraction 4,
R1-2,
X1-2,
SBase1-2,
R2-3,
X2-3,
SBASE2-3,
R3-1,

Three Winding Transformer Data Fields - continued

X3-1,
SBASE3-1,
VMSTAR,
ANSTAR,
WindV1,
NomV1,
Ang1,
Summer Rating A1,
Summer Rating B1,
Summer Rating C1,
Winter Rating A1,
Winter Rating B1,
Winter Rating C1,
COD1,
Control Bus 1 Region,
Control Bus 1 Area Number,
Control Bus 1 Area Name,
Control Bus #(CONT1),
Control Bus Name,
Control Bus KV,
RMA1,
RMI1,
VMA1,
VMI1,
NTP1,
TAB1,
CR1,
CX1,
WindV2,
NomV2,
Ang2,
Summer Rating A2,
Summer Rating B2,
Summer Rating C2,
Winter Rating A2,
Winter Rating B2,
Winter Rating C2,
COD2,
Control Bus 2 Region,
Control Bus 2 Area Number,
Control Bus 2 Area Name,
CONT2,
Control Bus 2 Name,
Control Bus 2 KV,
RMA2,

Three Winding Transformer Data Fields - continued

RMI2,
VMA2,
VMI2,
NTP2,
TAB2,
CR2,
CX2,
WindV3,
NomV3,
Ang3,
Summer Rating A3,
Summer Rating B3,
Summer Rating C3,
Winter Rating A3,
Winter Rating B3,
Winter Rating C3,
COD3,
Control Bus 3 Region,
Control Bus 3 Area Number,
Control Bus 3 Area Name,
CONT3,
Control Bus 3 Name,
Control Bus 3 KV,
RMA3,
RMI3,
VMA3,
VMI3,
NTP3,
TAB3,
CR3,
CX3

Two Terminal DC Tie Data Fields

In Service Date,
Out Service Date,
I,
MDC,
RDC,
SETVL,
VSCHD,
VCMOD (1,0),
RCOMP,
DELTI,
METER (R,I),
DCVMIN,
CCCITMX,
CCCACC,
IPR REGION NAME,
IPR AREA#,
IPR AREA NAME,
IPR Bus#,
IPR BUS NAME,
IPR BUS Kv,
NBR,
ALFMX,
ALFMN,
RCR,
XCR,
EBASR,
TRR,
TAPR,
TMXR,
TMNR,
STPR,
ICR REGION NAME,
ICR AREA#,
ICR AREA NAME,
ICR BUS#,
ICR BUS NAME,
ICR BUS kV,
IFR REGION NAME,
IFR AREA#,
IFR AREA NAME,
IFR BUS#,
IFR BUS NAME,
IFR BUS KV,
ITR REGION NAME,
ITR AREA#,

Two Terminal DC Tie Data Fields

ITF AREA NAME,
ITR BUS#,
ITR BUS NAME,
ITR BUS KV,
IDR,
XCAPR,
IPI REGION NAME,
IPI AREA#,
IPI AREA NAME,
IPI Bus#,
IPI BUS NAME,
IPI BUS Kv,
NBI,
GAMMX,
GAMMN,
RCI,
XCI,
EBASI,
TRI,
TAPI,
TMXI,
TMNI,
STPI,
ICI REGION NAME,
ICI AREA#,
ICI AREA NAME,
ICI BUS#,
ICI BUS NAME,
ICI BUS kV,
IFI REGION NAME,
IFI AREA#,
IFI AREA NAME,
IFI BUS#,
IFI BUS NAME,
IFI BUS KV,
ITI REGION NAME,
ITI AREA#,
ITI AREA NAME,
ITI BUS#,
ITI BUS NAME,
ITI BUS KV,
IDI,
XCAPI

- Notes:** (1) The data formats must be compatible with PSS®E input requirements.
(2) The in-service and out-of-service dates will be expressed as mm/dd/yyyy.

SECTION: APPENDIX II NUMBER RANGE ASSIGNMENTS FOR ERAG MMWG STEADY-STATE DATA

Region	Bus Numbers	Area Numbers	Zone Numbers	Owner Numbers
Entire System	100,000 - 899,999	100 to 899	100 to 1,899	100 to 1,199
NPCC	100,000 to 199,999	100 to 199	100 to 199 and 1,100 to 1,199	100 to 199
RFC	200,000 to 299,999	200 to 299	200 to 299 and 1,200 to 1,299 and 1,800 to 1,899	200 to 299
SERC	300,000 to 399,999	300 to 399	300 to 399 and 1,300 to 1,399	300 to 399
FRCC	400,000 - 499,999	400 to 499	400 to 499 and 1,400 to 1,499	400 to 499
SPP	50,000 to 599,999	500 to 599	500 to 599 and 1,500 to 1,599	500 to 599 and 800 to 899
MRO	600,000 to 699,999	600 to 699	600 to 699 and 1,600 to 1,699	600 to 699
ERCOT (future)	700,000 to 799,999	700 to 799	700 to 799 and 1,700 to 1,799	700 to 799

1 Area or zone number 1 is sometimes used as a default when the number is omitted by mistake. Its use to number an actual area should be avoided.

SECTION: APPENDIX III UTILIZED IMPEDANCE CORRECTION TABLES

Table Number	Tap or Angle	1 Factor	Tap or Angle	2 Factor	Tap or Angle	3 Factor	Tap or Angle	4 Factor	Tap or Angle	5 Factor	Tap or Angle	6 Factor	Tap or Angle	7 Factor	Tap or Angle	8 Factor	Tap or Angle	9 Factor	Tap or Angle	10 Factor	Tap or Angle	11 Factor
1	-60	1	-36	0.358	-24.4	0.192	-12.4	0.054	-8.3	0.024	0	0.01	8.3	0.024	12.4	0.054	24.4	0.192	36	0.358	60	1
2	-70	1	-43	0.78	-32	0.85	0	0.5	32	0.85	43	0.78	70	1	0	0	0	0	0	0	0	0
3	-180	1	-150	0.5	0	0.5	150	0.5	180	1	0	0	0	0	0	0	0	0	0	0	0	0
4	-152	1	-121.5	0.625	-85.4	0.372	-42.2	0.217	0	0.157	42.2	0.217	85.4	0.372	121.5	0.625	152	1	0	0	0	0
8	-40	1.848	-30	1.468	0	1	30	1.538	40	1.83	0	0	0	0	0	0	0	0	0	0	0	0
10	-25	1.995	0	1	25	1.995	0	0	0	0	0	0	0	0	0	0	0	0	0	0	0	0
11	-25	1.995	0	1	25	1.995	0	0	0	0	0	0	0	0	0	0	0	0	0	0	0	0
12	-40	1.66	-29.5	1.331	-25.1	1.228	-20.6	1.145	0	1	20.6	1.145	25.1	1.228	29.5	1.331	40.1	1.66	0	0	0	0
13	-40	1.849	-30	1.402	-20	1.196	-10	1.045	0	1	10	1.045	20	1.161	30	1.366	40	1.741	0	0	0	0
16	-30	1.913	0	1	30	1.913	0	0	0	0	0	0	0	0	0	0	0	0	0	0	0	0
17	-47	6.34	-41.7	5.44	-33.3	4	-27.5	3.06	-18.5	2	0	1	18.5	1.76	27.5	3.278	33.3	3.643	41.7	5.25	47	1
18	-40	2.31	0	1	40	2.31	0	0	0	0	0	0	0	0	0	0	0	0	0	0	0	0
19	-40	7.35	-30	4.85	-20	2.9	-10	1.6	0	1	10	1.6	20	2.9	30	4.85	40	7.35	0	0	0	0
20	0.937	1.641	1	1	1.03	1.02	1.1	1.427	0	0	0	0	0	0	0	0	0	0	0	0	0	0
21	0.889	0.575	1.04	1	1.2	2.89	0	0	0	0	0	0	0	0	0	0	0	0	0	0	0	0
22	0.8	1.563	0.85	1.384	0.9	1.235	0.95	1.108	1	1	1.05	0.907	1.1	0.826	1.15	0.756	1.2	0.694	1.25	0.64	1.3	1
23	-10	1	5	0.655	20	1.449	0	0	0	0	0	0	0	0	0	0	0	0	0	0	0	0
25	-60	9.2	-46.38	4.69	-32.3	1.87	-20	1	0	1	18	1	32.3	3	46.38	5.54	60	9.2	0	0	0	0
31	-15	2.076	0	1	15	2.076	0	0	0	0	0	0	0	0	0	0	0	0	0	0	0	0
32	-15	1.62	0	1	15	1.62	0	0	0	0	0	0	0	0	0	0	0	0	0	0	0	0
33	-5.7	2.061	0	1	5.7	2.061	0	0	0	0	0	0	0	0	0	0	0	0	0	0	0	0
34	-10	1.782	0	1	10	1.782	0	0	0	0	0	0	0	0	0	0	0	0	0	0	0	0
35	-30	1.65	0	1	30	1.65	0	0	0	0	0	0	0	0	0	0	0	0	0	0	0	0
37	-15	2.076	0	1	15	2.076	0	0	0	0	0	0	0	0	0	0	0	0	0	0	0	0
40	-40	1	-35	0.75	-25	0.6	-12.5	0.55	-7.5	0.52	0	0.5	7.5	0.52	12.5	0.55	25	0.6	35	0.75	40	1
42	-42.5	1.784	-32.6	1.497	-22	1.26	-11.1	1.07	0	1	11.1	1.05	22	1.193	32.6	1.443	42.5	1.782	0	0	0	0
44	-52.9	1.9024	-43.6	1.6768	-33.7	1.4512	-23.2	1.2256	-12.3	1	-1.2	1.1385	9.9	1.2769	20.9	1.4154	31.4	1.5539	0	0	0	0

SECTION: APPENDIX IV

UTILIZED DC LINES

<u>DC Line Number</u>	<u>Region</u>	<u>Name</u>		<u>DC Line Number</u>	<u>Region</u>	<u>Name</u>
1	MRO			26	NPCC	
2	MRO			27	NPCC	
3	MRO			28	NPCC	
4	MRO			29	NPCC	
5	MRO			30	RFC	
6	MRO			31	RFC	
7	MRO			32	Unused	
8	MRO			33	Unused	
9	MRO			34	Unused	
10	MRO			35	Unused	
11	NPCC			36	NPCC	
12	NPCC			37	NPCC	
13	NPCC			38	NPCC	
14	NPCC			39	NPCC	
15	NPCC			40	Unused	
16	NPCC			41	SPP	
17	NPCC			42	SPP	
18	NPCC			43	SPP	
19	NPCC			44	SPP	
20	NPCC			45	SPP	
21	NPCC			46	MRO	
22	NPCC			47	MRO	
23	NPCC			48	MRO	
24	NPCC			49	MRO	
25	NPCC			50	Unused	

SECTION: APPENDIX V SYSTEM CODES FOR USE IN ERAG MMWG STEADY-STATE DATA

NPCC – Northeast Power Coordination Council

<u>Area #</u>	<u>ID</u>	<u>System</u>
101	ISO-NE	ISO New England
102	NYISO	New York ISO
103	IESO	Independent Electric System Operator
104	TE	TransEnergie
105	NB	New Brunswick Power
106	NS	Nova Scotia Power
107	CORNWALL	Cornwall

RFC – Reliability First Corporation

<u>Area #</u>	<u>ID</u>	<u>System</u>
201	AP	Allegheny Power
202	FE	FirstEnergy
205	AEP	American Electric Power
206	OVEC	Ohio Valley Electric Corporation
207	HE	Hoosier Energy Rural Electric Cooperative, Inc.
208	DEM	Duke Energy Midwest
209	DAY	Dayton Power & Light Company
210	SIGE	Southern Indiana Gas & Electric Company
215	DLCO	Duquesne Light Company
216	IPL	Indianapolis Power & Light Company
217	NIPS	Northern Indiana Public Service Company
218	METC	Michigan Electric Transmission Co., LLC
219	ITCT	International Transmission Company
220	IPRV	Illinois Power- Riverside Plant
222	CE	Commonwealth Edison
225	PJM	PJM 500 kV System
226	PENELEC	Pennsylvania Electric Company
227	METED	Metropolitan Edison Company
228	JCP&L	Jersey Central Power & Light Company
229	PPL	PPL Electric Utilities
230	PECO	PECO Energy Company
231	PSE&G	Public Service Electric & Gas Company
232	BG&E	Baltimore Gas & Electric Company
233	PEPCO	Potomac Electric Power Company
234	AE	Atlantic Electric
235	DP&L	Delmarva Power & Light Company
236	UGI	UGE Utilities, Inc.
237	RECO	Rockland Electric Company
295	WEC	Wisconsin Electric Power Company (ATC)
	ESE	Edison Sault Electric (American Transmission Company - ATC)

SERC – SERC Reliability Corporation

<u>Area #</u>	<u>ID</u>	<u>System</u>
314	BREC	Big Rivers Electric Corporation
320	EKPC	East Kentucky Power Cooperative
330	AECI	Associated Electric Cooperative Inc.
331	BCA	Batesville
332	LAGN	Louisiana Generating Company
333	CWLD	Columbia, MO Water and Light
334	WESTMEMP	West Memphis
335	CONWAY	Conway
336	BUBA	Benton Utilities Balancing Authority
337	PUPP	Panda Union Power Partners
338	DERS	City of Ruston
339	DENL	City of North Little Rock
340	CPLE	Carolina Power & Light Company – East
341	CPLW	Carolina Power & Light Company – West
342	DUKE	Duke Energy Carolinas
343	SCEG	South Carolina Electric & Gas Company
344	SCPSA	South Carolina Public Service Authority
345	DVP	Dominion Virginia Power
346	SOUTHERN	Southern Company
347	TVA	Tennessee Valley Authority
349	SMEPA	South Mississippi Electric Power Association
350	AEC	Alabama Electric Cooperative
351	EES	Entergy Electric System
352	YAD	APGI – Yadkin Division
353	SEHA	Hartwell - SEPA
354	SERU	Russell - SEPA
355	SETH	Thurmond – SEPA
356	AMMO	Ameren Missouri
357	AMIL	Ameren Illinois
360	CWLP	City of Springfield (IL) Water Light & Power
361	SIPC	Southern Illinois Power Cooperative
362	EEL	Electric Energy Incorporated
363	LGEE	E.ON.US

FRCC Florida Reliability Coordination Council

<u>Area #</u>	<u>ID</u>	<u>System</u>
401	FPL	Florida Power & Light
402	PEF	Progress Energy Florida
403	FTP	Fort Pierce Utility Authority
404	GVL	Gainesville Regional Utility
405	HST	City of Homestead
406	JEA	Jacksonville Electric Authority
407	KEY	City of Key West
409	LWU	City of Lake Worth Utility
410	NSB	Utilities Commission of New Smyrna Beach
411	FMPP	Florida Municipal Power Pool
412	SEC	Seminole Electric Cooperative
414	STK	City of Starke
415	TAL	City of Tallahassee
416	TECO	Tampa Electric Company
417	FMP	FMPA / City of Vero Beach
418	NUG	Non-Utility Generators
419	RCU	Reedy Creek Energy Services, INC.
421	TCEC	Treasure Coast Energy Center
426	OSC	Osceola at Holopaw (PEF)
427	OLEANDER	Oleander IPP at Brevard (FPL)
428	CALPINE	Calpine at Recker (TECO)
431	VAN	IPS Avon Park at Vandolah (PEF)
433	HPS	Hardee Power Station (TECO)
436	DESOTOGEN	Desoto Generation IPP at Whidden (FPL)
438	IPP-REL	Reliant at Indian River (FMPP)

SPP – Southwest Power Pool, Inc.

<u>Area #</u>	<u>ID</u>	<u>System</u>
502	CELE	Central Louisiana Electric Company
503	Lafa	Lafayette Utilities
504	LEPA	Louisiana Energy and Power Authority
505	ALEX	City of Alexandria
507	RAYB	Rayburn Country Electric Cooperative
508	NTEC	North Texas Electric Cooperative
509	SRGT	Sam Rayburn G&T
511	AREC	Arkansas Electric Cooperative
513	CLWL	City of Clarksdale
514	MEAM	Municipal Energy Agency of Mississippi
515	SWPA	Southwestern Power Administration
520	AEPW	American Electric Power
522	KAMO	Kamo Electric Cooperative
523	GRDA	Grand River Dam Authority
524	OKGE	Oklahoma Gas and Electric Company
525	WFEC	Western Farmers Electric Cooperative
526	SPS	Southwestern Public Service
527	OMPA	Oklahoma Municipal Power Authority
531	MIDW	Midwest Energy
534	SUNC	Sunflower Electric Cooperative
536	WERE	Westar
537	SIKE	City of Sikeston, Missouri
539	WEPL	Westplains Energy
540	MIPU	Missouri Public Service Company
541	KAPL	Kansas City Power and Light Company
542	KACY	Board of Public Utilities
544	EMDE	Empire District Electric Company
545	INDN	City of Independence
546	SPRM	City Utilities of Springfield

MRO – Midwest Reliability Organization

<u>Area #</u>	<u>ID</u>	<u>System</u>
600	XEL	Xcel Energy North
	MUNI	Municipal data from Xcel Energy
	MMPA	MMPA Municipal data from Xcel Energy
	CMPA	CMPA Municipal data from Xcel Energy
608	MP	Minnesota Power & Light
613	SMPA	Southern Minnesota Municipal Power Association
615	GRE	Great River Energy
620	OTP	Otter Tail Power Company
627	ALTW	Alliant Energy West
633	MPW	Muscatine Power & Water
635	MEC	MidAmerican Energy
	CBPC	CBPC Municipal data from MEC
	RPGI	RPGI Municipal data from MEC
	IAMU	IAMU Municipal data from MEC
	MMEC	MEC Municipal data from MEC (AMES,CFU, etc.)
640	NPPD	Nebraska Public Power District
	MEAN	Municipal Energy Agency of Nebraska (NPPD)
	GRIS	Grand Island (NPPD)
645	OPPD	Omaha Public Power District
650	LES	Lincoln Electric System, NE
652	WAPA	Western Area Power Administration
	MPC	Minnkota Power Cooperative, Inc.
	BEPC	Basin Electric Power Cooperative
	NWPS	Northwestern Public Service
	MRES	Missouri River Energy Services
661	MDU	Montana-Dakota Utilities Co.
667	MHEB	Manitoba Hydro
672	SPC	Saskatchewan Power Co.
680	DPC	Dairyland Power Cooperative
	WPPI	Wisconsin Public Power Inc.
694	ALTE	Alliant Energy East (ATC)
696	WPS	Wisconsin Public Service Corporation (ATC)
	CWP	Consolidated Water Power Company (ATC)
	MEWD	Marshfield Electric and Water Company (ATC)
	MPU	Manitowoc Public Utilities (ATC)
697	MGE	Madison Gas and Electric Company (ATC)
698	UPPC	Upper Peninsula Power Company (ATC)

ERCOT & WECC

<u>Area #</u>	<u>ID</u>	<u>System</u>
700	ERCOT	Electric Reliability Council of Texas, Inc.
800	WECC	Western Electricity Coordinating Council

SECTION: APPENDIX VI

MOD-032-1 – ATTACHMENT 1

The table, below, indicates the information that is required to effectively model the interconnected transmission system for the Near-Term Transmission Planning Horizon and Long-Term Transmission Planning Horizon. Data must be shareable on an interconnectionwide basis to support use in the Interconnection-wide cases. A Planning Coordinator may specify additional information that includes specific information required for each item in the table below. Each functional entity¹ responsible for reporting the respective data in the table is identified by brackets “[functional entity]” adjacent to and following each data item. The data reported shall be as identified by the bus number, name, and/or identifier that is assigned in conjunction with the PC, TO, or TP.

steady-state <i>(Items marked with an asterisk indicate data that vary with system operating state or conditions. Those items may have different data provided for different modeling scenarios)</i>	dynamics <i>(If a user-written model(s) is submitted in place of a generic or library model, it must include the characteristics of the model, including block diagrams, values and names for all model parameters, and a list of all state variables)</i>	short circuit
<ol style="list-style-type: none"> 1. Each bus [TO] <ol style="list-style-type: none"> a. nominal voltage b. area, zone and owner 2. Aggregate Demand¹³ [LSE] <ol style="list-style-type: none"> a. real and reactive power* b. in-service status* 3. Generating Units¹⁴ [GO, RP (for future planned resources only)] <ol style="list-style-type: none"> a. real power capabilities - gross maximum and minimum values b. reactive power capabilities - maximum and minimum values at real power capabilities in 3a above c. stationing service auxiliary load for normal plant configuration (provide data in the same 	<ol style="list-style-type: none"> 1. Generator [GO, RP (for future planned resources only)] 2. Excitation System [GO, RP(for future planned resources only)] 3. Governor [GO, RP(for future planned resources only)] 4. Power System Stabilizer [GO, RP(for future planned resources only)] 5. Demand [LSE] 6. Wind Turbine Data [GO] 7. Photovoltaic systems [GO] 8. Static Var Systems and FACTS [GO, TO, LSE] 9. DC system models [TO] 10. Other information requested by the Planning Coordinator or Transmission Planner 	<ol style="list-style-type: none"> 1. Provide for all applicable elements in column “steady-state” [GO, RP, TO] <ol style="list-style-type: none"> a. Positive Sequence Data b. Negative Sequence Data c. Zero Sequence Data 2. Mutual Line Impedance Data [TO] 3. Other information requested by the Planning Coordinator or Transmission Planner necessary for modeling purposes. [BA, GO, LSE, TO, TSP]

¹³ For purposes of this attachment, the functional entity references are represented by abbreviations as follows: Balancing Authority (BA), Generator Owner (GO), Load Serving Entity (LSE), Planning

Coordinator (PC), Resource Planner (RP), Transmission Owner (TO), Transmission Planner (TP), and Transmission Service Provider (TSP).
² For purposes of this item, aggregate Demand is the Demand aggregated at each bus under item 1 that is identified by a Transmission Owner as a load serving bus. An LSE is responsible for providing this information, generally through coordination with the Transmission Owner.

³ Including synchronous condensers and pumped storage.

<p>manner as that required for aggregate Demand under item 2, above).</p> <ul style="list-style-type: none"> d. regulated bus* and voltage set point* (as typically provided by the TOP) e. machine MVA base f. generator step up transformer data (provide same data as that required for transformer under item 6, below) g. generator type (hydro, wind, fossil, solar, nuclear, etc) h. in-service status* <p>4. AC Transmission Line or Circuit [TO]</p> <ul style="list-style-type: none"> a. impedance parameters (positive sequence) b. susceptance (line charging) c. ratings (normal and emergency)* d. in-service status* <p>5. DC Transmission systems [TO]</p> <p>6. Transformer (voltage and phase-shifting) [TO]</p> <ul style="list-style-type: none"> a. nominal voltages of windings b. impedance(s) c. tap ratios (voltage or phase angle)* d. minimum and maximum tap position limits e. number of tap positions (for both the ULTC and NLTC) f. regulated bus (for voltage regulating transformers)* g. ratings (normal and emergency)* h. in-service status* 	<p>necessary for modeling purposes. [BA, GO, LSE, TO, TSP]</p>	
---	--	--

<p>7. Reactive compensation (shunt capacitors and reactors) [TO]</p> <ul style="list-style-type: none">a. admittances (MVars) of each capacitor and reactorb. regulated voltage band limits* (if mode of operation not fixed)c. mode of operation (fixed, discrete, continuous, etc.)d. regulated bus* (if mode of operation not fixed)e. in-service status* <p>8. Static Var Systems [TO]</p> <ul style="list-style-type: none">a. reactive limitsb. voltage set point*c. fixed/switched shunt, if applicabled. in-service status* <p>9. Other information requested by the Planning Coordinator or Transmission Planner necessary for modeling purposes. [BA, GO, LSE, TO, TSP]</p>		
--	--	--

SECTION: APPENDIX VII

Modeling of Generator Parameters

1. Applicable Facilities - The following Generators and SVCs connected to BES (100 kV and greater) or in accordance with the SPP OATT or Member OATT.
 - a. All Individual units greater than 20 MVA (gross nameplate rating)
 - b. All Synchronous Condensers greater than 20 MVA (gross nameplate rating)
 - c. Generating plant/facilities greater than 75 MVA (gross aggregate nameplate rating)

Modeling Process for Generator Parameters

- a. The Generator parameter P_{MAX} shall be modeled as a gross seasonal maximum capability based on MOD-025-02 and SPP Planning Criteria 7.1 testing and reporting procedures.
- b. Generating plant station service and auxiliary loads shall be represented in normal plant configuration, corresponding to the load appropriate to operation of the generating plant. All station service and auxiliary load representations shall:
 - i. Be modeled explicitly on the appropriate bus15, corresponding to the voltage to which the auxiliary load is served. Model representations of auxiliary load connected to the generating unit bus (Figure VII-1), auxiliary load modeled with separate transformation (Figure VII-2), and auxiliary load modeled on the high-side bus of the station service transformer (Figure VII-3) are acceptable.
 - ii. Be annotated as non-scalable.

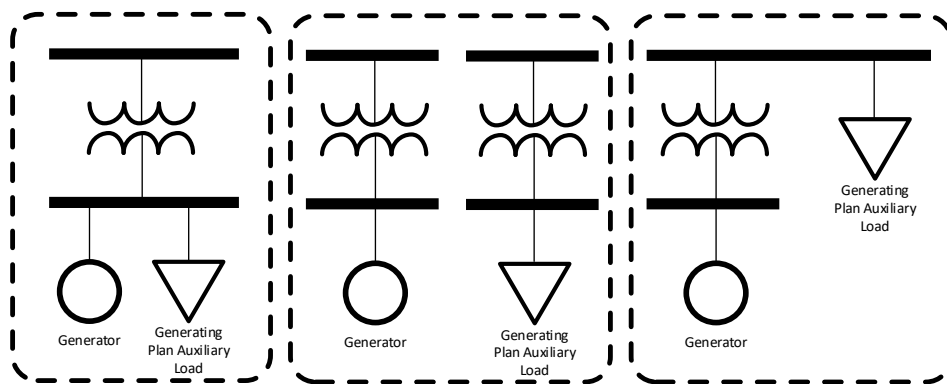

Figure VII-1. Common bus representation

FigureVII-2. Separate transformation representation

FigureVII-3. Transformer high-side representation

15 Station service and auxiliary load shall not be netted against generating plant dispatch by reducing the P_{gen} of a unit with an amount corresponding to the plant auxiliary load.

- c. Experience has shown that generating plant station service and auxiliary load may vary considerably based upon generating plant dispatch and operating conditions. Therefore, generating plant station service and auxiliary load may be modeled as aggregated or non-aggregated generating plant load, representing the total quantity of fixed and variable station service and auxiliary load.

If generating plant station service and auxiliary load is **aggregated**, the total load quantity shall properly reflect the total real and reactive loading for the generating units. The aggregated generating plant station service and auxiliary load shall use “SS” in the Load ID field (Figure VII-4a). If there are more than one aggregated generating plant station service and auxiliary load, use “Sn” in the Load ID field to delineate the multiple aggregated loads.

If generating plant station service and auxiliary load is **not aggregated**, each load quantity shall properly reflect the real and reactive loading expected during the corresponding dispatch (e.g., generating plant Pgen may be less than Pmax) and operating conditions for the generating units. Combined loads are analogous to aggregating generating plant station service and auxiliary load, with additional detail specifying the fixed and variable portions of total generating plant load (Figure VII-4b). The combined or discrete (Figure VII-4b and Figure VII-4c) load representations shall:

- i. Use “Fn” in the Load ID field¹⁶ to designate fixed load quantities that do not vary with plant dispatch.
- ii. Use “Vn” in the Load ID field⁴ to designate variable load quantities that do vary with plant dispatch.

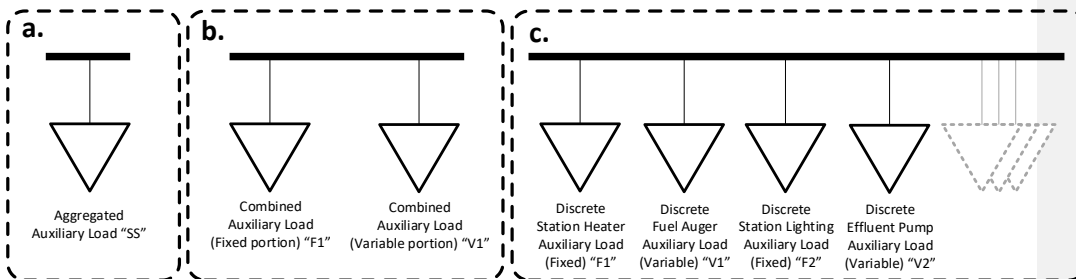

Figure VII-4. Examples of generating plant auxiliary load representations (aggregated, combined, and discrete).

- d. The Generator Parameters for PMIN, AUX Load, QMAX, and QMIN shall be modeled in accordance with MOD-025-02 and SPP Planning Criteria 7.1 testing and reporting procedures.

Modeling of Wind/Solar Renewable Resources P_{GEN}

¹⁶ “n” represents a unique numeric value. PSS/E requires each load placed at a bus to have a unique Load ID.

- Light load models: Output of renewable resources with long-term firm transmission service will be modeled in the light load model at each facility's latest five-year average (or replacement data if unavailable) for the SPP coincident off-peak hour corresponding to the season of the Light Load case, not to exceed each facility's firm service amount. Solar resources will be modeled at zero MW output in the light load case regardless of the facility's long-term firm transmission service amount.
- Peak models: Output of renewable resources with long-term firm transmission service will be modeled in the case(s) at each facility's latest five-year average (or replacement data if unavailable) for the applicable seasonal SPP coincident¹⁷ peak, not to exceed each facility's firm service amount.
- SPP will make available the initial dispatch of renewable resources with long-term firm transmission service based on historical seasonal five-year average with the initial model pass of the each SPP MDWG model build.
- When an affected party disagrees with the dispatch amount for a facility, the affected parties involved should coordinate to update the dispatch amount. If agreement cannot be reached, the case can be brought to the MDWG for a decision.
- Responsibility for validating and providing renewable resource dispatch updates falls to the affected parties.

Data Exemption Process

MDWG Members requested that there be a process by which the modeled generator maximum is different from the MOD-025-02/SPP Planning Criteria testing. In accordance with Attachment 1, Section 5 of MOD-025-02 an exception process for generators that have undergone testing per MOD-025-02/SPP Planning Criteria 7.1 for these differences is as follows:

1. Member will fill out the "Exemption Form" and send it via e-mail to "Engineering Modeling" containing:
 - a. Generator Name
 - b. Generator Bus Number
 - c. Requested change(s) that deviate from the MOD-025-02/SPP Planning Criteria testing.
 - d. Justification of the change if it is greater than or less than 5% of the MOD-025-02/SPP Planning Criteria testing.

SPP Modeling will process the Exemption and communicate back to the member requesting the exemption that it has been granted or if additional information is needed to process the exemption within 30 days of submission of the request.

****Effective date of sections 1&3 is in effect.**

****Effective date of section 2 is July 1, 2016.**

****Effective date of section 4 is July 1, 2016.**

¹⁷ SPP coincident peak equals the highest demand including transmission losses for energy measured over a one clock hour period during the defined season.

SECTION: APPENDIX VIII - BALANCING AND TRANSACTIONS

Background

A core principal of steady-state power flow modeling¹⁸ is the balance between load and generation. A system swing generating unit is a fundamental requirement of the modern formulation of the linear power flow problem (net complex power injection into nodal admittance network). In the balanced three-phase power flow formulation, a swing generator serves the imbalance of power for the entire electrical network. However, in real power systems, Balancing Authorities ensure that frequency regulation is achieved by matching generation to load within a subsection of the entire interconnected power system. Thus, in most power flow software, a vast impedance network may be segregated into groups of busses representing a model area¹⁹. While typically analogous to a Balancing Authority Area or control area, the concept of a model area is straightforward: model areas allow the electrical network to be sectioned in such a way as to pool together generation, loads, and losses for the purpose of scheduling power flows throughout the electrical network. Model areas are not limited to being demarcated by physical load balancing boundaries; on the contrary, model areas are very effective at allowing individual generation and load-serving companies to properly allocate resources and demand, including transactions with other model areas. While most power flow software enforces that each generating unit inherits its model area designation from the bus to which it is connected, many modern power flow software packages allow ZIP²⁰ loads and induction machine loads to be assigned to model areas that may be different than the busses to which they are connected. In this way, each generating unit and load is grouped into common balancing pools, represented by the model area (Figure 1).

¹⁸ The traditional power flow formulation is the matrix algebraic calculation of voltage phasor (magnitude and angle) at each interstitial connectivity node (bus) within an impedance network under balanced three-phase, steady-state conditions.

¹⁹ Model areas typically have a single generator designated as the area slack machine, although this is not a modeling constraint. The area slack machine is analogous to the system swing machine in that it compensates for the power imbalance within the model area, when the power flow solution is solved to respect inter-area transfers (area net interchange control).

²⁰ ZIP refers to constant impedance, constant current, or constant power load representations, including a combination of each.

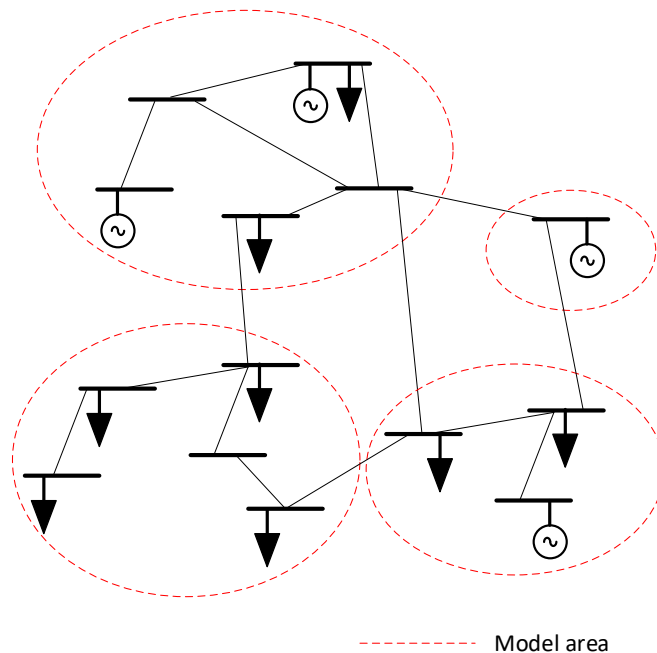

Figure 1. Example of interconnected model areas.

To be clear: it is inappropriate to refer to either a “generation area” or a “load area”. Instead, it is important to understand that the modeling concept of the “Area” field designated for bus, load, and generation refers to the model area to which that model object belongs. To reiterate, the model area to which a load is assigned indicates which generation resources will serve that load, independent of the model area of the bus to which that load is attached. This concept is of particular importance when interchange is used to obtain power flow solutions.

Within each model area that contains generating units, a single generating unit must be designated as the slack machine. While the dispatch (Pgen) of each non-slack generating unit is set to a prescribed value, the slack machine dispatch varies to compensate for any imbalance within the model area. In many cases, load obligations and transmission losses associated with delivering power to the loads within a model area may not be totally served by the capacity of resources in-service within a model area. In these situations, inter-area transfers are common, representing power purchase agreements (PPA) that reflect the firm purchase or sale of power from generation resource in one model area to another for the purpose of serving load. Similarly, intra-area transfers representing contractual or PPA obligations between resource and load owners within a model area are also common. In total, all inter- and intra-area transfers are referred to as “transactions” and must be properly accounted for to achieve power flow model balancing and accurate model area tie-line loading.

Across the entire interconnected impedance network, one-and-only-one generating unit must be designated as the system swing unit. The system swing serves any overall imbalance arising from

imbalanced exchanges between individual model areas. In its simplest expression, the model area designation facilitates the analysis of scheduled power flow between interconnected regions of the impedance network, which is useful for assessing conventional tie-line loading. More broadly, however, the use of model areas allows exchanges of generating resources that are intended to serve loads that may be very distant from the actual generating unit, giving rise to bilateral transactions across model area boundaries, integrated market operations, and efficient resource dispatch, as well as others.

Load is generally served by generation resources within a common model area. Likewise, both the load and the bus to which the load is connected reflect a common model area (as shown in the Area field of each). The same principle applies to transacted resource-to-load; loads that serve as the sink portion of a transacted real power quantity will reside in the model area of the sink Data Owner (and may retain the load ID of the Data Owner of the load itself). Exceptions are called pseudo-ties, representing where the resource that serves the load is outside of the model area where the load resides. Pseudo-tied loads are typically found when the Area field assigned to the load is different than the Area field of the bus, to which the load is connected, however generation pseudo-ties are possible, as well. For modeling purposes, pseudo-tie representations are permitted between two model areas within the SPP Balancing Authority (referred to an intra-SPP pseudo-tie), as well as between a model area within the SPP Balancing Authority and a model area of a non-SPP Balancing Authority (referred to an inter-SPP pseudo-tie). Intra-SPP pseudo-ties can be an effective means of differentiating which model area provides resource to unique load delivery obligations, but may be problematic if used to avoid proper resource, load, and loss accounting through model area transactions. Separately, inter-SPP pseudo-tie arrangements are typically unique contractual arrangements where firm transmission service (e.g., network services, point-to-point) has been pre-arranged to direct resource from/to an external model area, into/out of a model area where the load resides (see Figure 2). Inter-SPP pseudo-tied loads are generally an exception to the norm and the use of inter-SPP pseudo-tied loads should be justified (e.g., reference to an SPP load-balancing meter point, pseudo-tie registration in the SPP marketplace, etc.). Data Owners shall not create pseudo-tie modeling representations of load that incorporates fictitious topology; Data Owners may create pseudo-tie modeling representations of generation necessary, given the load flow software constraints.

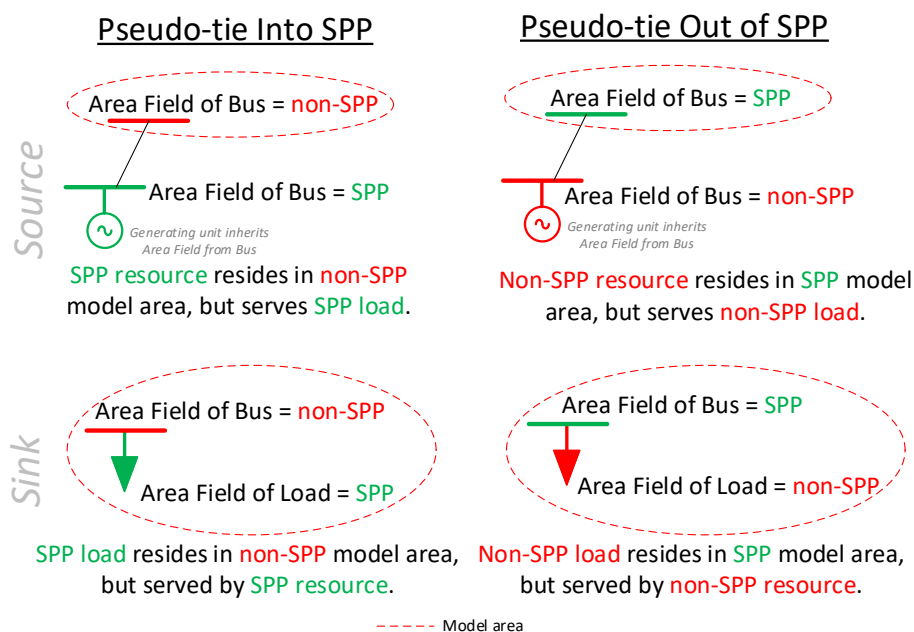

Figure 2. Four types of inter-SPP pseudo-ties.

Transactions Data Requirements

Data Owners shall submit all transactions data via the MDWG Data Submittal Workbook. Additionally, Data Owners shall:

1. Coordinate all bilateral transactions data with all Data Owners who are party to the transaction, prior to submitting the data.
2. Submit only the bilateral portion of the transaction for which the Data Owner is responsible. For example, in a bilateral transaction between two Data Owners (SPP-members), each Data Owner shall submit one half of the transaction (source or sink). In the case of a bilateral transaction between a Data Owner (SPP-member) and a non-SPP member, such as a MISO-member, the Data Owner (SPP-member) shall submit their portion (source or sink) of the bilateral transaction, upon coordination with the non-SPP member. SPP staff will then submit the non-SPP member portion (source or sink) of the bilateral transaction.
3. Review and update transactions data according to the model building schedule.
4. Load and resource transactions may be inter-area (i.e., reciprocal transaction from an SPP Market Participant to another SPP Market Participant, both within the SPP Balancing Authority Area) or external area (i.e. traditional BA-to-BA interchange). Transactional data collected by Data Owners often have tens of kilowatts precision. However, for the purposes of the ERO, or its designee, Interconnection-wide models,

external net interchange schedules are required to be entered as whole MW quantities. Therefore, Data Owners shall submit transaction data according to:

- a. Inter-area transactions (transactions of load and resource that are wholly contained within the SPP Balancing Authority Area) are preferred to be integer values (i.e. whole MW); however, shall not exceed tens of kilowatt precision (i.e., two decimal MW precision; 0.01MW).
 - b. External area transaction (i.e. scheduled net interchange between the SPP Balancing Authority and an external Balancing Authority) shall be rounded to the nearest integer (i.e. whole MW).
5. Ensure that source transactions have positive polarity, while sink transactions have negative polarity (Figure 3 and Figure 4).

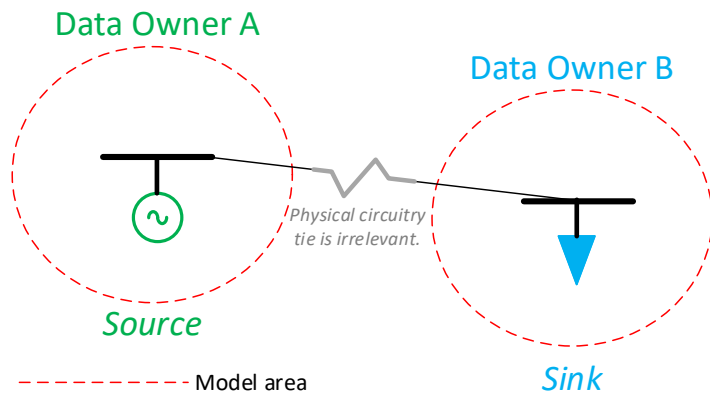

Inter-area Bilateral transaction description

Data Owner A exports MW to Data Owner B

Data Owner B imports MW from Data Owner A

Transaction accounting in Data Submittal Workbook

PC	From Area #	From Area	From Resp Entity #	From Resp Entity Name	To Area #	To Area	To Resp Entity #	To Resp Entity Name	ID	Start	Stop	Firm	201x Series MDWG Model - 18G
SPP	1	Area 1	1	Data Owner A	2	Area 2	2	Data Owner B	ABC111	12/1/2013	3/1/2020	X	MW
Not SPP	2	Area 2	2	Data Owner B	1	Area 1	1	Data Owner A	ABC111	12/1/2013	3/1/2020	X	-MW

Figure 3. Example of Inter-area transfer (transaction).

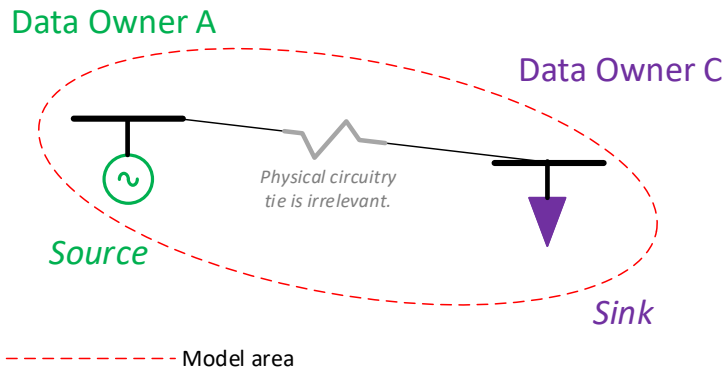

Intra-area Bilateral transaction description

Data Owner A exports MW to Data Owner C

Data Owner C imports MW from Data Owner A

Transaction accounting in Data Submittal Workbook

PC	From Area #	From Area	From Resp Entity #	From Resp Entity Name	To Area #	To Area	To Resp Entity #	To Resp Entity Name	ID	Start	Stop	Firm	201x Series MDWG Model - 18G
SPP	1	Area 1	1	Data Owner A	1	Area 1	1	Data Owner C	XYZ112	12/1/2013	3/1/2020	X	MW
SPP	1	Area 1	1	Data Owner C	1	Area 1	1	Data Owner A	XYZ112	12/1/2013	3/1/2020	X	-MW

Figure 4. Example of Intra-area transfer (transaction).

6. Complete the following required Data Submittal Workbook data fields for each source and sink portion of a bilateral transaction:
 - a. Planning Coordinator (PC).
 - b. From Area #.
 - c. From Area Name.
 - d. From Responsible Entity #.
 - e. From Responsible Entity Name.
 - f. To Area #.
 - g. To Area Name.
 - h. To Responsible Entity #.
 - i. To Responsible Entity Name.
 - j. Transaction ID.
 - k. Transaction Start date.
 - l. Transaction Stop date.
 - m. Firm or Non-Firm Transaction.
 - n. Transaction quantity (in MW) for all appropriate seasonal MDWG Model Series cases.

7. When a part or all of a bilateral transaction is referenced by an Open Access Same-Time Information System (OASIS) number, used by the marketer for scheduling, enter the OASIS number in the appropriate Data Submittal Workbook field.
8. The following Data Submittal Workbook information is reserved for SPP staff usage and is not required from the Data Owner of each bilateral transaction:
 - a. From Attributes.
 - b. To Attributes.
 - c. Link Number.
 - d. Plant.
 - e. Capacity.
 - f. Roll Over Rights.
 - g. S0 Scalable.
 - h. S5 Scalable.
 - i. OASIS Comment.
 - j. Comments.
 - k. Related Reference.



**MODEL DEVELOPMENT
PROCEDURE MANUAL**
Model Development Working Group

June 2018

MODEL DEVELOPMENT WORKING GROUP

REVISION HISTORY

DATE OR VERSION NUMBER	AUTHOR	CHANGE DESCRIPTION	COMMENTS
2018 v1	SPP Engineering Modeling	Updated format	
2018 v1.1	SPP Engineering Modeling	Modified Bus Naming and Map / Model request information	
<u>2018 v1.2</u>	<u>SPP Engineering Modeling</u>	<u>Updated Introduction & Dynamic modeling section</u>	

SECTION 1: INTRODUCTION

Purpose

This manual establishes consistent modeling data requirements and reporting procedures for the development of Near-term and Long-term Transmission Planning Horizon models necessary to support analysis of the capability, reliability, and suitability of the SPP Transmission System. This section describes the applicability of entities, data owners, equipment, and data submitters to which this manual is germane.

The latest modeling data requirements and reporting procedures for the Planning Coordinator's planning area, the "SPP MDWG Model Development Procedure Manual" jointly developed with each of the PC's Transmission Planners, can be found on the SPP corporate website, www.spp.org. Additionally, the schedule for submission of data and the list of MDWG models (case types/scenarios) can also be found on the SPP corporate website, www.spp.org. The schedule for model development will also be sent with the first data request.

The primary deliverable of the SPP MDWG is a set of base transmission system models (base cases) that include a reasonable projection of the anticipated transmission system conditions as will be operated by the SPP Transmission Operators (TOPs) in coordination with the SPP Reliability Coordinator (RC). The primary intent of these base cases is to provide SPP member Transmission Planners (TPs) and the SPP Planning Coordinator (PC) an effective starting point for reliability planning and compliance assessments. In addition, the base cases are developed in support of various SPP planning processes in accordance with SPP model data and reporting procedures that include maintenance and coordination of steady state, short circuit, dynamic, and geomagnetic disturbance models.

These base cases are a collection of transmission system data, as submitted annually to the SPP PC by applicable Data Submitters, meant to represent the transmission system in the SPP region in a steady-state, system-intact condition. The system topology, generator dispatch, and system loads modeled in the base cases are intended to be respective and representative of the projected transmission system as will be operated within the SPP footprint under reasonably anticipated weather and time-of-day conditions for the year and season being represented in each base case. Reasonable projections within each case include all firm generator commitments, forecasted load commitments, firm interchange commitments, expected transmission topology and expected seasonal transmission or generation outages. Additionally, base cases may include reasonable system projections based on details specified in later sections of this document and based on historical data or projected data.

Scope of Applicability

It is well understood that transmission system modeling is a complex process predicated upon accurate and comprehensive data collection, review, and compilation. The SPP Model Development Working Group recognizes that to properly develop SPP Transmission System models, a constituency of responsible entities must collaborate in the model building effort. The transmission system subject to the SPP OATT including facilities 60kV and above must be accounted for in the SPP Transmission System models. Therefore, consistent with both the applicability of the NERC Data for Power System Modeling and Analysis Reliability Standard (MOD-032-1) ¹, and the provisions of the SPP Open Access Transmission Tariff (OATT), as well as good utility practice, this manual is applicable to the following NERC-registered and non-NERC-registered entities:

- Planning Coordinator;
- Balancing Authority;
- Transmission Service Provider;
- Transmission Planners;
- Transmission Owners² of equipment within the SPP Planning Coordinator planning area and/or of equipment that is part of the SPP Transmission System;
- Owners or lessors of generating units, including Generator Owners, within the SPP Planning Coordinator planning area of Network Resource(s) designated by the SPP OATT and/or who have submitted a Generation Interconnection Request consistent with the SPP OATT.
- Resource Planners;
- Distribution Providers;
- Network Customers receiving Network Integration Transmission Service pursuant to the SPP OATT for designated Network Load and/or having arranged Point-To-Point Transmission Service for non-designated load;
- Native Load Customers of an SPP Transmission Owner;
- Transmission Customers pursuant to the SPP OATT.

It is noted that within the SPP Region, consistent with SPP Regional Transmission Organization (RTO) procedures and the SPP OATT, SPP serves as both a Balancing Authority³ and Transmission Service Provider for the SPP Transmission System.

Applicable Data Owners

A subset of the applicable entities annotated above comprise the Data Owners subject to the modeling data requirements and reporting procedures of this manual:

¹ The NERC petition to remove the Load Serving Entity (LSE) registration was approved by 153 FERC ¶ 61,024, issued 15 October 2015. Therefore, the LSE registration is not discussed in this manual.

² Capitalization is intended to include transmission-owning entities as defined in the NERC Glossary of Terms, as well as defined in the SPP OATT.

³ For Eastern Interconnection equipment only. WAPA-UGPR independently operates the WAUW BA area within the Western Interconnection for equipment which is under the SPP OATT.

- Balancing Authority is responsible for submitting modeling data for aggregated existing and future load, integrated resource plans, and interchange obligations corresponding to the case conditions specified.
- Transmission Service Provider is responsible for submitting modeling data for their existing and future service commitments and obligations corresponding to the case conditions specified.
- Distribution Providers are responsible for submitting modeling data for their aggregated existing and future load, and interchange obligations corresponding to the case conditions specified.
- Transmission Owners are responsible for submitting modeling data for their existing and future Transmission or sub-transmission equipment that they own or maintain.
- Owners or lessors of generating units, including Generator Owners, are responsible for submitting modeling data for the existing and future generating equipment that they own or maintain.
- Resource Planners are responsible for submitting modeling data for their existing and future long-term resource adequacy plan(s) of specific customer load demand and energy requirements, corresponding to the case conditions specified.
- Network Customers are responsible for submitting modeling data for their existing and forecasted load, existing and forecasted load transactions, as well as existing and forecasted resource transactions corresponding to the case conditions specified.
- Native Load Customers are responsible for submitting modeling data for their existing and forecasted load corresponding to the case conditions specified.
- Transmission Customers are responsible for submitting modeling data for their existing and forecasted transactions utilizing the SPP Transmission System, serving Network Load, or sales of Network Resources corresponding to the case conditions specified.

Applicable Data Submitters

The Data Owner shall be the Data Submitter, subject to the modeling data requirements and reporting procedures of this manual. A Data Submitter may be designated as the entity who takes responsibility for collating, formatting, and corresponding a Data Owner's modeling data to SPP, as Planning Coordinator, in the approved format. A Data Submitter may be delegated only if the following are completed:

1. Data Submitter is designated in writing, showing mutual agreement by the Data Owner and Data Submitter.
2. Written notification is provided to SPP, as Planning Coordinator, regarding the specific data (e.g., load at bus X; generating unit Y; transmission branch Z) for which the Data Submitter will be responsible for.

Responsibility for the timely and accurate submission of Data Owner information to SPP, as Planning Coordinator, resides with the Data Owner.⁴ When a Data Owner delegates the submission of data to a Data Submitter, all communication that would otherwise be sent to the Data Owner alone, will be copied to the Data Submitter.

A Data Owner's submitted data shall not modify another Data Owner's data without explicit consent. Data Owners are encouraged to coordinate data submissions that may impact another Data Owner's system.

⁴ When delegated, the Data Submitter is not responsible for validating data provided by the Data Owner.

Applicable Equipment

The modeling data required from Data Owners supports both the creation of the Electric Reliability Organization (“ERO”), or its designee, Interconnection-wide modeling cases, and the other Near-term and Long-term Transmission Planning Horizon cases required under the SPP OATT⁵. Planned equipment, as differentiated from existing equipment, consists of equipment expected to be in-service for the case conditions specified (e.g., month; year). Existing or planned⁶ equipment for which non-equivalenced⁷ modeling data shall be reported include, but are not limited to:

1. All Facilities comprising the BES.
2. All non-BES equipment 60 kV and above, subject to the SPP OATT⁸.
3. All BES or non-BES equipment that includes a normally-open point that, when closed, shifts load or creates a network path affecting the SPP Transmission System.
4. All non-BES equipment interconnecting within the SPP Transmission System or interconnecting the SPP Transmission System with non-SPP Transmission System(s), subject to the SPP OATT⁹.
5. All non-BES equipment known to have a significant interaction with the BES, including reactive resources.
6. All direct-current connections within the SPP region or interconnecting to Transmission outside of the SPP region.
7. All Network Resource generation assets, subject to the SPP OATT¹⁰, excluding Small Generating Facilities (< 2MW).
8. All Network Resource (pursuant to Item 7) generator step-up transformers and generator interconnection equipment. Generator interconnection equipment shall include, at a minimum, collector electrical equivalent representations, where applicable.
9. All Resources that are registered in the SPP Integrated Marketplace, including the transmission equipment necessary to delivery that Resource to the SPP Transmission System when the registered Resource is not directly connected to the SPP Transmission System.
10. All Network Load, subject to the SPP OATT¹¹.
11. All firm power purchases served by SPP Network Resource(s) and firm power sales sunk to SPP Network Load, including all firm power transactions that result in an area interchange.

Other information regarding equipment not specified above may be requested by SPP, as the Planning Coordinator, or by Transmission Planner(s) for modeling purposes, as necessary. Likewise,

⁵ Pursuant to the provisions of the OATT, equipment below the typical 100kV demarcation of the BES must be accounted for in the SPP Transmission System models.

⁶ As part of the MDWG model building process to support of the TPL-001-4 R1 model building requirement

⁷ Equivalentencing is a general technique that substitutes power system equipment with a simplified representation that closely approximates the characteristics and behavior of the actual equipment.

⁸ Sixth Revised Volume No.1, Attachment AI, Part II-1.

⁹ Sixth Revised Volume No.1, Attachment AI, Part II-2.

¹⁰ Sixth Revised Volume No.1, Part III-30.

¹¹ Sixth Revised Volume No.1, Part III-31

consistent with MOD-032-1 Requirement R3, the Planning Coordinator or Transmission Planner may request additional data or clarification regarding technical concerns with modeling data submitted. Written notification will typically be communicated through electronic means (e.g., email) to the Data Submitter and/or Data Owner and will include the technical concerns with the data submitted. Upon receipt of written notification, the Data Submitter and/or Data Owner shall respond to the notifying Transmission Planner or SPP, as the Planning Coordinator, with either updated data or an explanation with a technical basis for maintaining the current data in accordance with the reporting procedure schedule (“schedule”) jointly developed by the Transmission Planners and Planning Coordinator.

Accountability

SPP, through coordination with the MDWG, cannot be effective at building timely and accurate models without Applicable Entity participation. All Applicable Entities are responsible for providing the data necessary to model their Applicable Equipment. Likewise, Applicable Entities are accountable for meeting specific deadlines and milestones established by the MDWG, for model development, in the jointly developed schedule. The schedule will be made available to all Applicable Entities at the outset of each model-building period.

Clear and timely two-way communication between SPP, as Planning Coordinator, the Transmission Planners comprising the SPP PC, and Applicable Entities is vital to the successful compilation of modeling data, reporting, and ultimate production of accurate SPP Transmission System models. It is the responsibility of the Applicable Entity to communicate with SPP to establish the responsible contact for steady state, dynamic, and short circuit model data coordination.

Given that the MDWG relies upon Data Owner and Data Submitter input for the model building effort, the following are some of the established characteristics that support model-building best practices:

- Establishes a contact for model data coordination.
- Responds to model-building communications in a timely fashion.
- Data Owner begins coordinating data submittal well in advance of the initial model data submittal deadline.
- Submits model data ahead of established deadlines.
- Submit majority of model updates by initial model data submittal deadline.
- Ensures model data submitted is complete and accurate.
- Participates in MDWG conferences, calls and meetings.
- Performs a data integrity review of each model-building pass to identify and correct errors.
- Engages throughout the model-building process in a timely fashion.
- Keeps their respective managerial chain informed about model-building progress.
- Coordinates data submissions that may impact another Data Owner’s system.

Following each model-building cycle, SPP staff, in conjunction with MDWG members, will prepare a lessons-learned and modeling best practice recommendations assessment. This assessment will focus on challenges experienced by the preceding model-building cycle, attempt to identify root causes, and suggest improvements for subsequent model-building cycles.

MDWG experience has shown that some natural obstacles exist to achieving model-building best practices. The following cautionary situations are examples for the purpose of Data Owner and Data Submitter awareness during the model-building process:

- Appropriate lead times. Data Owners may rely on other entities to provide data; therefore, Data Owners should consider lead times when requesting data from others (e.g., Data Owner entity X is the Market Participant and Network Load registrant who serves a municipal customer). Knowing that source data may be more difficult or slower to obtain, the Data Owner should act as early as possible so not to delay the submission of data until late in the model-building process.
- An early and complete submission of a Data Owner's modeling data does not eliminate the need for the Data Owner to participate in all model-building passes. In many cases, model parameters that affect multiple Data Owners within a region (e.g., load, generation dispatch, and transactions) may change between model iterations. The aggregation of these changes can have a pronounced effect on the model data that Data Owners have submitted and emphasizes the need for checking/re-checking the integrity of a Data Owner's model representations in each model iteration.

During each model iteration, an assessment of model-building progression and participation may be performed. Given that incomplete or late data submission has a tremendous impact upon the ability to meet the model-building schedule, any Data Owner who seeks to submit late data will be obligated to present before the MDWG about how proposed model changes will impact the models themselves, as well as impacts to the overall modeling schedule. The MDWG has the obligation to report its progress and achievement of model-building milestones to various SPP working groups/committees.

In cases where an Applicable Entity has not participated or otherwise supported MDWG efforts in good faith towards the achievement of published milestones, the MDWG may report non-participating entities to the TWG/MOPC.

General Data Reporting Responsibilities

The SPP data reporting entities are responsible for the following categories of system modeling data:

1. Steady-State
2. Short Circuit
3. Dynamics

Steady-State models are developed for an annual series of SPP cases, including an annual series of ERAG MMWG cases. Specific models are prepared and modified for use in SPP designated studies as required by SPP Regional Tariff and Planning Criteria.

Short Circuit models are developed annually using a subset of the Reliability Steady-State models. All base MDWG steady-state models will include sequence data (including applicable mutual line impedance data) for the SPP footprint. The following 3 versions of short circuit models will be built:

1. MDWG steady-state base model
2. MDWG steady-state with PSS@E Classical assumptions
3. Maximum Fault case

The Base MDWG Short Circuit models are built by performing the following steps:

1. Extract the SPP RAW and SEQ data with ties from the final MDWG steady-state model
2. Extract the first tier company's RAW and SEQ data without ties from the final SERC Short Circuit model built by the Short Circuit Database Working Group (SCDWG)
3. Merge the two data sets together

The Classical assumptions MDWG Short Circuit Models are built by performing the following step:

1. Apply Classical assumptions to the Base MDWG Short Circuit model as described in the PSS@E Program Operation Manual

Maximum Fault cases are built by performing the following steps:

1. Place in-service (Apply a status of '1') all SPP planned and available existing generation and transmission facilities to the Base MDWG Short Circuit model
2. Apply Classical assumptions

The Dynamics Model is also updated annually with current generator unit information. Steady-State models are used in conjunction with dynamic data to run dynamic simulation.

System representatives should be responsive with good modeling techniques. SPP data models are used by individual systems for studying future needs in developing construction forecasts. Not planning a major expenditure by one year due to inaccurate data could be very expensive, since funding allocation for major construction projects requires more time resources. In addition, ATC, megawatt-mile and incremental losses are currently being calculated with these Steady-State models. With the large amount of interconnection within SPP, the impact of one system on another must be recognized and respected. Therefore, each system should prepare data consistent with its most recent official system forecasts in all data submitted to SPP including Energy Information Agency (EIA-411) Data. It is also important that the models represent the expected operation of the SPP system consistent with this manual and Planning Criteria.

Entities in the SPP Planning Coordinator region that are not members of the SPP but required to submit data (i.e. IPPs, Municipalities) will submit data directly to the Transmission Owner or Balancing Authority in which their system resides. Upon review (i.e. data accuracy, quality) by the Transmission Owner or Balancing Authority the data will then be provided to the SPP during the annual MDWG case type update process. The data submitted will be in the standard PTI format as specified in the MDWG Model Development procedure manual. All non-SPP members that are responsible for submitting this data should directly coordinate with the Transmission Owner or Balancing Authority on timing for sending data, as well as any special requirements in data formatting.

In an effort to determine who is collecting/submitted data for whom, all NERC registered entities within the SPP PC footprint (MOD-032-1: applicable to BA, GO, LSE, RP, TO, TP, and TSP) shall fill out the data coordination workbook to notify SPP if data is being submitted directly to SPP or through some other entity(ies) on behalf of your company. Likewise, SPP shall be notified if your company is submitting data on behalf of another entity(ies).

Confidentiality and Proprietorship

The representation of future system elements in SPP data models is not an agreement to construct these elements when shown in the models or at any time. The configuration of each model system only reflects the necessary changes that the individual model system needs for maintaining reliable operation. The results of studies obtained through use of the data models developed by SPP will be the sole responsibility of the receiving party. The recipient of SPP data models must assure confidentiality and proprietorship.

Schedule

As with all schedules, the meeting of deadlines is most critical. All system representatives must familiarize themselves with the schedule well in advance of all deadlines. This will alleviate any problems with the timing of data submittal and data reviews. The [schedule](#) for model development will be sent with the first data request as well as posted on the SPP corporate website, www.spp.org.

Steady-State and Short Circuit Model Development

The MDWG Steady-State and Short Circuit models are developed using data gathered through the SPP database Model On Demand (MOD) in conjunction with the [EDST Data Submittal Workbook](#). MOD data is divided into three parts: a Base Case, Projects, and Profiles (Bus, Loads, Generation, and Device Control). Modeling updates for transmission system topology can be made by submitting a Project to MOD. Non-topological modeling updates that are season specific can be made by submitting Profiles to MOD. Additional required data is submitted through the [EDST Data Submittal Workbook](#) which is identified in the data preparation section of this manual.

SPP MDWG Steady-State and Short Circuit Models are published according to the approved schedule.

AC Contingency Analysis

SPP will perform AC Contingency Analysis on all models contained in the steady-state case type set.

The purpose of this contingency analysis is to validate the models. Member updates for errors found due to contingency analysis are to be submitted during the next member data submission period per the latest [MDWG model building schedule](#).

Dynamic Model Development

Introduction

The MDWG Dynamic Models include full MMWG cases and machine reduced cases. The initialized no-fault models can be solved with quarter-cycle and half-cycle time steps. The MDWG Dynamic model Update is used to support SPP reliability studies and ERAG MMWG Dynamic model requirements. It is important for all generating entities that interconnect to the SPP transmission to support the Regional Transmission Organization with current detailed dynamics data in the proper SPP model format. The current MDWG Dynamic Model Format is PSS@E dynamics DYRE and RAWD formats.

The Dynamics Model data includes:

1. Steady-State models
2. Dynamics model data in Siemens PTI PSS@E DYRE format
3. User written model source and object code (includes wind farms)
4. ERAG MMWG System Dynamics Database (SDDB)
5. SDDB data update worksheet

SPP MDWG Dynamic Models are published according to the schedule in Section 15 B.

MODEL DEVELOPMENT

Data Preparation

The following section describes important items that must be followed in the development of a steady-state model in preparing the data for publishing new models or updating existing models.

1. The data listed in Attachment 1 of the NERC Standard MOD-032-1 located on the [NERC](#) website.
2. MOD data should be kept current for each pass during the MDWG model build.
3. The [Data Submittal WorkbookEDST](#) contains informational data as well as modeling data that Data Submitters shall keep current for each pass of the MDWG model build.
4. Transaction – Firm and non-firm reservations with other entities that shall be coordinated before submission to SPP (Reference appendix VIII for more information).
5. Generator Data – Required generator data that is not otherwise captured in the models.
6. SPP Modeling Assignments – Contains PSSE modeling area, owner, zone, and bus range information pertinent to SPP.
7. Load Mapping – Identify loads not served by native Control Areas.
8. Data Dictionary – List of all buses in the models that includes long names, voltage level, area, owner, and EIA plant codes.
9. Interregional Ties – PC to PC branch and transformer ties that shall be coordinated before submission to SPP.
10. Outages – Outages known during the annual model building process for buses, generators, branches, transformers, and shunts with a duration of at least six months shall be modeled. Data Submitters are responsible for annotating known outages to be modeled within the [data submittal workbookEDST](#), as well as ensuring that the known outages are correctly modeled in the appropriate season(s) when the known outage is scheduled. MOD projects shall be submitted with effective dates corresponding to the scheduled period of the known outages.

Table 1: Season Date Range and Cutoff Dates

Season	Date Range	Cutoff (On or Before)
Spring	April 1 – May 31	May 1
Light	April 1 – May 31	May 1
Summer	June 1 – September 30	August 1
Summer Shoulder	June 1 – September 30	August 1
Fall	October 1 – November 30	November 1
Winter	December 1 – March 31	February 1 (yyyy+1)*

*Example of Winter: 12/1/2017 – 3/31/2018; yyyy+1 = 2018

Steady-State and Short Circuit Data Format

PSS@E and MOD Users

The transmission modeling software approved by the SPP membership for performing planning and reliability studies is the Power Technologies Incorporated, Power System Simulator for Engineering (PSS@E) software. Data submitted for the building of the base SPP MDWG case types (models) needs to be in a format consistent with that used in PSS@E. The data shall be submitted via the SPP Models On Demand (MOD) Web Portal. Data submitted should be compatible with the MOD and PSS@E versions currently specified by SPP.

Non-PSS@E and Non-MOD Users

For those non-PSS@E users, load and generation profile data may be submitted via the Profile Submission form provided by SPP. SPP will aid with the submission of all other steady-state data in the correct PSS@E and MOD data formats. Any version changes will be discussed in the annual training provided by SPP.

Dynamic Data Format

PSS@E Users

Dynamics data needs to be submitted in the form of a flat text file or dyre file compatible with Siemens PTI PSS@E dyr file software. Dyre file submittals can be of changes to individual components from the existing dyre entries or of entire new representation of machines. Dynamic ready models are developed using the PSS@E software program. The data should be submitted via [GlobalScape](#) or email. Data submitted must be compatible with the PSS@E version currently specified by SPP.

Non-PSS@E Users

Dynamics data needs to be submitted in the form of a flat text file or dyre file compatible with Siemens PTI PSS@E software. Siemens PTI PSS@E Software contains dyre file models for most conventional machines, exciters, governors, SVCs, HVDC ties, wind resources, and solar resources. SPP Modeling staff will work with the responsible entity or its designee to translate operational test data into the appropriate dyre file format compatible with the PSS@E version currently specified by SPP.

NERC maintains a list of acceptable excitation and governor system models on the NERC website for reference by the GO. The acceptable list can be found on the NERC SAMS website→SAMS Reference Materials→NERC Acceptable Model List.

Dynamic model data must be in a Siemens PTI PSS@E standard library model format. User-written dynamic models will only be allowed under the following conditions:

- 1) Technical justification as to why the user-written model should be used in place of the Siemens PTI PSS@E standard library model in consideration of a regional transmission system analysis.
- 2) Dynamic model data is submitted in .dyr format
- 3) Dynamic model data is submitted in .lib or .dll format for compilation and linking purposes
- 4) Documentation, including Block Diagram, in .pdf or .docx format
- 5) A written commitment to SPP and the applicable Transmission Planner(s) indicating that user-written models will be either: 1) replaced with standard library models; or 2) added to the PSSE/PSLF set of standard dynamic models within one year of the following applicable event:

- a. The date of commercial operation for planned facilities with an executed GIA
- b. The date of receipt of notification for existing facilities

For existing facilities, a written commitment within 1 year, user-written model that can be added to the PSSE and PSLF standard Dynamic Model libraries.

The members are expected to contact the SPP Modeling Staff if there are any additional questions regarding the data format.

Responsible Entities

Commented [MO1]: Add high level process in the appendix or Guidance Document for MOD-026/027

Commented [MO2]: Dynamic models that are not considered acceptable by NERC, shall be converted to the applicable acceptable dynamic model within x years.

Commented [MM3]: This paragraph would invoke R3 of MOD-032. The request should come from SPP and both the applicable TPs and SPP GI group should be included.

Need to take the spirit of this language to Attachment V and Appendix B of the Pro Forma GIA Milestones (GI Studies). The MDWG doesn't want to be the "Manual Police". Instead, this should be an upfront requirement before a GO signs a GIA.

Formatted

Commented [MO4]: Appendix item. Check with SPP Legal on language. Include a deliverable date.

Data owners are responsible for providing the data necessary to model their assets to its Transmission Planner(s) and Planning Coordinator(s) as described in this document. Data owners and their respective data submission responsibilities are noted in the NERC standard MOD-032-1.

1. Generator Owners (GO) and Resource Planners (RP) are responsible for submitting modeling data for their existing and future generating facilities respectively.
2. Load Serving Entities (LSE) are responsible for submitting modeling data for their existing and future load corresponding to the case types developed.
3. Transmission Owners (TO) are responsible for submitting modeling data for their existing and future transmission facilities.
4. The Planning Coordinator or Transmission Planner can request other information necessary for modeling purposes from the BA, GO, LSE, TO, or TSP.

Typical Annual Models

Season	Season
1 Annual Spring Peak	9 Annual + 1 Summer Peak
2 Annual Summer Shoulder	10 Annual + 1 Fall Peak
3 Annual Summer Peak	11 Annual + 1 Winter Peak
4 Annual Fall Peak	12 Annual + 2 Summer Peak
5 Annual Winter Peak	13 Annual + 2 Winter Peak
6 Annual + 1 April Minimum	14 Annual + 6 Summer Peak
7 Annual + 1 Spring Peak	15 Annual + 6 Winter Peak
8 Annual + 1 Summer Shoulder	16 Annual + 10 Summer Peak

The typical yearly models developed by the SPP MDWG, as identified within the NERC TPL reliability standards, encompass both near-term (years one through five) and longer-term (years six through ten) transmission planning models. The SPP models are defined in the **Annual Models** table above with those transmission planning models representing the near-term planning horizon consisting of the MDWG case types 1 through 13 and those representing the longer-term planning horizon consisting of the MDWG case types 14 through 16. The longer-term models may be incremented or additional models may be included as required to support ERAG MMWG.

The annual series of models are developed by SPP staff with input from the Model Development Working Group and the Transmission Working Group.

The [schedule](#) for submission to data and list of MDWG models ([case types](#)) can be found on the SPP

corporate website, www.spp.org.

Transactions modeled in all base cases should be limited to expected firm schedules and should not include other transfers such as emergency power or opportunistic economy energy even though they may be provided for in contractual agreements. Due to FERC's ruling of Roll-over rights, Long Term Firm Transactions should be considered in the models that extend into the future even if the transaction has a stop date. For a transaction to be considered firm, the transaction must be confirmed at both the source end and the sink end. Southwest Power Pool will do its best to confirm delivery of transactions outside of the Pool boundaries.

Firm transmission load includes capacity dependent interruptible loads with buy through provisions. In other words load that may be interrupted if the source runs out of capacity should still be modeled if the load has a choice and opportunity to purchase power from another source. This firm transmission load should be modeled in all cases. The load modeling entity is responsible for scheduling the power from a source and updating the transaction worksheet (see Appendix VIII).

Load Forecast

Load forecasting methodologies vary throughout the electric industry. SPP depends on load forecasts from Data Submitters to apply to the planning models. These load forecast amounts are to be Non-Coincident to the SPP region, meaning that the hour that a Data Submitter's system experiences a peak demand for a particular season, might not be the same hour that SPP, as a region, experiences a peak demand. In order to bring consistency and equivalency to the load forecast data submitted to SPP, load forecast data shall be based on a 50/50 forecast.

A 50/50 load forecast relates to a forecasted load amount having an equal probability of being either higher or lower than the amount forecasted. The forecasted load value is at the 50th percentile of a normal or similarly shaped distribution curve and is typically discussed in terms of exceedance such that there is a 50% probability that the load forecast will be exceeded due to abnormal weather.

Some studies may require load forecasts other than a 50/50 load forecast and may be requested for such special studies. For example, a 90/10 load forecast has a 10% probability that the load forecast will be exceeded, which means the load forecast amount is higher than a 50/50 load forecast amount and would be considered atypical for general SPP transmission planning purposes.

There are various methods used to develop such forecasts and the forecasts are dependent upon many factors such as historical load values, temperature, humidity, economic forecasts, time of day, day of week, holidays, special events, and load uncertainty. Other factors, some of which are controllable, also impact the amount of forecasted load. Controllable Demand Side Management (DSM) and Distributed Energy Resources (DERs) are such factors.

Demand Side Management consists of activities or programs that an entity invokes to achieve a reduction in Demand. DSM consists of controllable and non-controllable systems. Load forecasts shall not be reduced for application of controllable DSM. There is control over whether or not the load will be shed by an operator or end-user and therefore cannot be guaranteed that the load will be reduced during peak hours. Load forecasts should be reduced for application of non-controllable DSM. This load has a high probability of being shed during peak hours without manual intervention. Distributed Energy Resources are power resources on the distribution system that can be aggregated together to provide power to meet Demand. For purposes of transmission

planning, it is recommended that Distributed Energy Resources should not be applied to a Data Submitter's load forecast amount for incorporation into the SPP planning models.

When it becomes necessary or desirable to make changes in delivery point facilities, to upgrade, retire, replace or establish a new delivery point, including metering or other facilities at such location, the provisions set forth in Attachment AQ of the SPP Open Access Transmission Tariff (OATT) shall apply. Loads that have completed the Attachment AQ process or any other applicable SPP process, and have a signed agreement, or are in the process of finalizing a signed agreement should be included in the Data Submitter's load forecast. SPP may reject any MOD projects or PSSE idews that attempt to add, delete or modify delivery points that have not been studied either through the Attachment AQ or any other applicable SPP process. Data Submitters are required to assign the appropriate type and status to load projects in MOD.

Summary of Data Submitter's load forecast data comprisal:

1. Non-coincident to the SPP region
2. 50/50 load forecast
3. Load forecast amount includes non-controllable Demand Side Management
4. Load forecast amount excludes controllable Demand Side Management
5. Load forecast amount excludes Distributed Energy Resources (recommended)

Seasonal peak models developed by SPP include: Summer Peak, Winter Peak, Spring Peak, and Fall Peak. These four seasonal models are built to represent the expected coincident seasonal peak based on each Data Owner/Data Submitter system peak load. Data Owner/Data Submitter peak load may not be coincident to the SPP Balancing Authority coincident peak.

In addition to the seasonal peak models, SPP develops two off-peak models. They include: a Light Load condition and a Summer Shoulder condition.

The Light Load model is developed with the intent to capture a Data Owner/Data Submitter system minimum load during the spring timeframe.

The Summer Shoulder model, also known as the seasonal on-peak average model is defined to be 70% - 85% of the total Summer Peak load level depending on the Data Owner/Data Submitter system.

Spring Peak (G):	April 1 st through May 31 st
Summer Peak (S):	June 1 st through September 30 th
Fall Peak (F):	October 1 st through November 30 th
Winter Peak (W):	December 1 st through March 31 st
Light Load (L):	April 1 st through May 31 st
Shoulder (SH):	70% - 85% of Summer Peak model

Data Owners of load that is pseudo-tied into SPP shall submit load forecasts to both SPP and the entity in which the load is embedded. Owners of load that is pseudo-tied out of SPP should submit load forecasts to the entity in which the load is embedded.

External load is load not affiliated with load forecasts submitted by SPP Data Submitters to SPP for planning model building purposes.

Area Summary Report

The Area Summary Report is an important part of data preparation and should be the initial step of the update process. This report, though not part of the steady-state input forms, is an important part of the data coordination process. As such, the report should be distributed to all appropriate systems at least one week before the initial update data is due at the SPP Office. The standard area abbreviations listed in Section 6-B should be used on the area summary report and in the steady-state input data of area interchange and transactions. The following sequence of steps is to be used in completing this report:

1. The system name and area number, along with the name and phone number of the person that prepared the report, should be entered at the top of the form in the appropriate location.
2. The area slack bus and bus number. The area slack bus is to adjust for individual system losses only. It is not necessary for the area slack bus to be used for area load control in actual operation. Generation dispatch should be made to prevent the area slack bus from going to negative power output or power output above the stated rating of the unit when accounting for area losses. It is best that the area slack bus not represent a base load unit. The estimated slack bus generation should also be entered (Item 7). There should be room left on the slack bus for generation movement up & down.
3. For consistency, it is important that each system continue using a particular area slack bus rather than choosing a different bus from year-to-year, unless a specific reason exists to justify such a change. There is a new row on the Area Summary Sheet to identify the slack bus. To aid in solution time of the cases, the area slack bus should be located on a relatively strong portion of the system.
4. The case year and season should be entered in the appropriate locations in chronological order.
5. The current system official load forecast should be entered as net load (Item 6).
6. The estimated losses should be entered (Item 5). The reference cases can be used as a starting point to estimate system losses.
7. Load equals net load minus estimated losses (Item 4).
8. Purchases and sales should be entered (Item 2). These values must be coordinated with the parties involved in the interchange transaction prior to data preparation. The algebraic sum of these transactions should be equal to the total area interchange.
9. Net power (Item 3) must equal net load (Item 6). Generation (Item 1) is equal to the net power plus interchange.

Tie Line Coordination

Each SPP system will receive a tie-line data comparison summary for the initial base case and after the final models are published. The member **must** coordinate with its neighbors on the tie line representation in the models being developed.

This coordination should consist of:

1. Agreement on which bus is to be metered for area loss accounting,
2. The in-service and out-of-service dates, if applicable,
3. Tie line characteristics and ratings
4. System responsible for supplying the update data.

SPP Member tie data (Intra-SPP) is maintained in a MOD Project file. The majority owner of the

tie is responsible for maintaining the tie's steady-state, sequence, and ratings data.

SPP tie data with external entities (Inter-PC) is maintained in the MMWG PC tie line list. Entities must submit changes using the latest list, which will be posted with the latest case set. Changes are to be highlighted in order for SPP Staff to easily discern the submitted changes. The file name shall contain the company name of which is submitting the change. There will be other lower voltage SPP ties which are not listed in the NERC list. They will be checked using the SPP tie line reports.

Line and Transformer Data

Additions to the system tend to move from year-to-year based on changing load growth forecasts and budget requirements. As a result, future lines and transformers may move through several future cases. Line and Transformer Data is contained in MOD Projects and phases. The Project Type, Status, and Phase Effective Date determine if the data will be included in a particular model. The line and transformer data formats are found in Section 5.

The following steps should be considered when preparing line and transformer data:

1. The device code (Bus, Branch, Transformer) specifies what data is being added to the base case. The action code (Add, Modify, Delete) specifies the action to be taken with the Project data. Specifying the deletion of a bus will require a similar record to delete all associated or connected devices with the bus (lines, generators, loads, transformers, etc.) from the base case.
2. The "from bus," "to bus", and circuit number identify the line or transformer. The order in which bus numbers are entered is important for tie lines to identify which bus is metered for loss accounting in some data formats. The "from bus" is assumed to be the metered end (unless the "to bus" is entered with a negative) and the "to bus" area will collect loss responsibility. For transformers, this order is also important in all formats because it specifies to which bus the Load Tap Changer (LTC) will attempt to maintain voltage and/or which bus is tapped. The code U in the branch data allows the user to select proper metered and tapped side by always entering the tapped side as the "from bus" or first bus number after the change code. The "from bus" is the metered end unless the "to bus" or second bus number is a negative number. Remember to include the circuit identifier.
3. The positive, zero, and negative sequence branch impedance data shall be provided on a 100 MVA base (per unit value). The smallest allowable reactance is 0.00011 P.U. on a 100 MVA base. Reactance values less than minimum will cause the steady-state program to treat the line as a zero impedance line to reduce solution time.
4. The positive, zero, and negative sequence line charging data (conductance and susceptance) shall be provided on a 100 MVA base (per unit value) as applicable. A default value of zero will be assumed if no data is provided. Line charging data will be divided in the appropriate units depending on the specific format being utilized. Accuracy is needed to ensure a proper voltage profile in the model.
5. Each SPP member shall rate transmission circuits in accordance with the SPP Planning Criteria (Section 7.2). This criterion calls for each member to compute, at a minimum, summer and winter seasonal ratings for each circuit element. Each Base

Case (Network) and Project branch, two-winding and three-winding transformer must have a specified rate A (normal) and rate B (long-term emergency) for spring, summer, fall, and winter. The ratings data format is in the MOD Procedure Manual.

6. The transformer tap and tap limits shall be specified. The use of LTC transformers should be kept to a minimum to help reduce the case solution time. Using LTC transformers for local area voltage control where no such transformer exists should be avoided. In general, regulating transformers should not be located at a bus with a regulating generator or other voltage regulating device; however, there may be exceptions based on current system topology and operating conditions.
7. Circuit mileage should be entered in the appropriate line length field of branch data. Ownership data for the line should also be entered in the appropriate fields of branch data. This mileage and ownership data will be used to validate and calculate Megawatt-mile for the SPP Regional Tariff. Circuit mileages should be coordinated on all jointly owned lines. Invalid line lengths result in inaccurate revenue allocations.
8. All NERC flowgates must be included in the data submitted by each region to the MMWG such that those flowgates are not equivalenced in the steady-state models. A flowgate is a selected transmission element or group of elements acting as proxy for the transmission network representing potential thermal, voltage stability, rotor angle stability, and contractual system constraints to power transfer. Enough detail should be added to model the flowgate accurately.
9. Transformer connection codes¹² and transformer winding angle (phase displacement) shall be provided. The connection code data incorporates concepts of the transformer core type, the vector group (phase differences between windings, standardized with clock notation indicating phase displacement), and physical conductor orientation. The transformer winding angle further specifies the inherent phase shift between transformer windings based upon configuration (vector group). Data Owners are reminded that changes to connection codes do not automatically alter the modeled phase displacement used for positive sequence load flow calculations.

Bus Data

For all SPP steady-state models, systems will model buses within their SPP allocated bus range (see Section 6-B). For the sake of consistency, the bus names and numbers should remain constant from case to case and year to year. All bus shunts will be modeled as switched shunt. The Switch Shunt may be locked. When a change in bus voltage occurs, a new bus number will be given to the new higher voltage bus. This enables SPP to track when the old bus voltage changes. All interregional tie bus names should conform to the entries in the Master Tie Line Database as approved by the Regional MMWG Coordinators. All tie line bus names and numbers should be standard and unique

¹² Reference PSS/E Program Operation Manual section: Two Winding Transformer Zero Sequence Network Diagrams and Connection Codes or Three Winding Transformer Zero Sequence Network Diagrams and Connection Codes

within each area in all models in a case series. Changes in tie line bus names and numbers from one series to the next must be kept to a minimum to reduce changes in computer support programs. Unique generator bus names, base voltages, and unit id combinations should be consistent from case to case within a model series. This will help ensure that the SPP bus names do not conflict with ERAG MMWG Standards.

The following steps describe options and data for most bus data formats:

1. The device code and the change code determine describes what action(s) are taken with the data supplied (addition, deletion, modification, etc...).

NOTE: When a bus is deleted or removed from service, all associated network devices (lines, transformers, loads, generators, etc.) must also be deleted or connected to a different bus in the applicable model(s).

Although voltage codes have no uniform association with voltage classes, historical consistency is encouraged amongst entities within a highly integrated network. Bus names can have up to 12 characters with the first character, preferably, alphabetic rather than numeric. The name should be left justified. Characters which can aid in filtering or association are allowed excluding the following characters: commas, asterisks, single quotes and double quotes. The last character field of the bus name should be the SPP voltage code described as follows. The historical SPP voltage code list shown below is recommended, but not required:

1 - Below 69 kV	4 - 138 kV	7 - 345 kV
2 - 69 kV	5 - 161 kV	8 - 500 kV
3 - 115 kV	6 - 230 kV	9 - 765 kV or above

1. For generator regulated buses, a desired voltage magnitude will be given. Generator buses should be modeled with operating characteristics as close to actual as possible. Generator ratings should also be specified for each generation bus (whether on or off-line) as described in SPP Planning Criteria Section 7.1. Generators shall model the gross output of the generating facility and explicitly model the station service auxiliary load. The practice of using generator for voltage support only (i.e. no real power output), should be avoided unless a synchronous condenser or static var controller physically exists on that bus or nearby in the system. When a generator is modeled offline (status 0), the MW (PGEN) and MVAR (QGEN) fields should be zeroed. Regulating transformers should not be located at a bus with a controlling generator or regulating shunt device.
2. Bus loads should be specified with the real and reactive values provided as a pair in all entries. The load should be modeled to reflect the expected in-service/out-of-service status.
3. When scaling area load, it is important to consider the reactive power as well as real power. This is particularly true when referencing a case of a different season. Realistic reactive load representation has a major effect on the overall case voltages. Reactive requirements are different for the various season models.

4. Capacitors, reactors, and SVCs represented in the models should be consistent with actual seasonal operation. These devices should be used in future cases calling for local area voltage support, rather than falsely regulating a bus. Attention should be given to these installations in cases that are referencing a different season model. Tertiary reactors should be modeled on the low voltage bus of transformers if the tertiary is not modeled explicitly.

Do not model existing or planned shunts on the Bus record. Shunts should be modeled in the Switched Shunt Record unless they are line shunts and trip when the line is opened. Bus shunt voltage bandwidth must be wide enough to prevent “hunting” of shunt value during steady-state solution of base case or contingency analysis. The switched shunts can be modeled as fixed shunts with specified B initial value.

Load Data

Load data is maintained in MOD via a profile file which is applied to the model. Profiles, Loads can belong to an Area that is not the same as the Bus Area. Refer to Section 5-A-3 for load data formats. The default solution technique will solve the case with Tie Lines and Loads. The Tie Lines and Loads solution option assumes that the Loads Area generation serves the load.

The Non-Scalable Loads will be identified in the Non-Scalable Load worksheet of the [Data Submittal Workbook EDST](#). This allows model builders to modify models without changing the loads that are constant.

Loads that are owned by municipal utilities should be modeled with an identifier in front of the number (i.e. Rayburn County load one should have the ID “R1”). These loads should be maintained in the Load Mapping worksheet of the [Data Submittal Workbook EDST](#).

Generator Data

Check Generator MW and Mvar output to ensure the unit is within the P_{MAX}, P_{MIN}, Q_{MAX}, Q_{MIN} and M_{base} limits per testing requirements in SPP Planning Criteria 7.1.1. Generator MW shall be set to “gross” level with auxiliary load modeled explicitly. Q_{max} and Q_{min} values in the models should be based on unit test data. Intermittent resources (e.g., wind and run-of-river hydro) should not normally be dispatched beyond their net capability as established by SPP Planning Criteria 7.1 for the summer and shoulder cases. Energy storage (pumped hydro, battery, flywheel, etc.) shall be modeled with the generator rated capabilities and a dispatch amount (P_{gen}) no greater than the rated output that can be sustained continuously for a minimum of one (1) hour. Ensure accurate values of Z_R and Z_X. This data is not needed in normal steady-state and equivalent construction work, but is required for switching studies, fault analysis and dynamic simulation. For dynamic simulation, **this complex impedance must be set equal to the sub unsaturated transient impedance for those generators modeled by sub transient level machine models**, and to transient impedance for those modeled by classical or transient level models. Machine Base (M_{BASE}) and Zero Impedance (Z_{SOURCE}) values for the steady-state models must match dynamic data. The MDWG steady-state models will use the saturated subtransient impedance data for generators (X’_{di}). Future Generators that are in the models but are not budgeted for construction need to be identified in the Generator Data worksheet of the [Data Submittal Workbook EDST](#).

When modeling mothballed and future retired units, the P_{max}, P_{min}, Q_{max}, and Q_{min} values should be modeled as zero. Decommissioned units should be removed from the models.

Shortfall Guidance Process

A shortfall is defined as an instance of insufficient firm resource to supply firm load. Under no circumstances in the Near-Term Transmission Planning Horizon shall generating resources be dispatched in excess of the firm transmission rights allotted to that resource. In the Long-Term Transmission Planning Horizon, if the resources within a modeling area and firm transactions from neighboring modeling areas are insufficient to serve customer load, the following should be investigated as potential modeling solutions to the shortfall:

1. Coordinate reciprocal non-firm transaction(s) with other modeling area(s). All parties are required to add their respective coordinated reciprocal record(s) to the transaction worksheet of the [data submittal workbook EDST](#).
2. Future generation resources that have progressed, at minimum, to the Interconnection Facility Study (per Attachment V, subsection 8.9) stage in the Generation Interconnection (GI) queue, may be modeled (in the Long-Term Transmission Planning Horizon models only) following these requirements.
 - a. The in-service date shall be based on the expected in-service date of the GI study.
 - b. In order to identify future GI queued generation, the unit name shall be the GI gen number (e.g. GEN-2017-898) and contain a unit ID of Zx (where x is any second ID designation appropriate in PSS@E).
 - c. Projects files that add future generation shall have the appropriate Type and Status which can be found in the SPP MOD Project Type/Status Matrix.
3. Future exploratory generation resources may be modeled in the Long-Term Transmission Planning Horizon models following these constraints:
 - a. In order to identify future exploratory generation, the unit ID of Zx (where x is any second ID designation appropriate in PSS@E) shall be used.
 - b. When available, exploratory generation should be based upon the host TO Resource Plan.
 - c. Projects files that add future generation shall have the appropriate Type and Status which can be found in the SPP MOD Project Type/Status Matrix.
 - d. The addition of exploratory generation shall be consistent with modeling practices that minimize the impact to power flows in neighboring transmission systems (e.g., exercise diligence in siting the exploratory generator topologically proximate to the load that uses its resource).

Remote Generation Modeling

Purpose

This procedure assures that members adhere to a uniform process when modeling remote generation in SPP.

Modeling Process

If a member acquires remote generation outside their Control Area (steady-state model numbered area), the following modeling process should be followed:

1. All buses should be assigned numbers that are in the host's control area bus number range.
2. Area Number/Name should be the host's control area number.
3. Zone Number/Name should be in the host's control area zone range.
4. Generation Owner Number should be the owner's designated ID number and percentage ownership.
5. The generation recipient should coordinate the output level and the inter-area transfer with the host control area.

Transaction Update

The transaction workbook should be updated to show a transaction from the control area where remote generation is located to the generation owner control area. If the remote generation is owned by multiple owners, then multiple transactions should be modeled.

Steady-State Data Check List

The steady-state data check list should be used as an aid for ensuring good model data. As the data and preliminary runs are reviewed for each model, the items should be checked off. A copy of this form can be found in **Section 7**.

Facilities Transferred to SPP’s Functional Control

The SPP FERC "Docket No. RT04-01-00 Volume 1", *In the July 2 Order, the Commission: ...(7) ordered that SPP file a list of all transmission facilities that will be transferred to its operational control and revise the Operational Authority White Paper ("OA White Paper") or Membership Agreement, or provide some other binding document, to reflect SPP's clear authority to exercise day-to-day control over the appropriate transmission facilities within its footprint...*

Attachment AI to the SPP Regional Tariff contains the criteria for inclusion of facilities that are considered "**Facilities Transferred to SPP’s Functional Control**". Transmission facilities meeting the definition set forth in Attachment AI must be included in the SPP MDWG Steady-State Models.

Owner Data and Line Mileage Data (SAS-70 Control)

Per SAS-70 requirements (i.e. – Loss calculations) SPP Loss models must be updated every June and October with current Owner Data and Line Mileage data. To meet the SAS-70 requirement the SPP models must include owner data and line-mileage data. SPP Staff will obtain this data from the MOD Base Case and Projects; therefore; it is important that Members keep the data current in MOD.

Zone Range Assignments

SPP Area

Refer to the most current SPP Area Zone Assignments.

MMWG Region

Region	Bus Numbers	Area Number	Zone Number	Owner Numbers
Entire System	100,000 to 899,999	100 to 899	100 to 1,899	100 to 1,199
NPCC	100,000 to 199,999	100 to 199	100 to 199 and 1,100 to 1,199	100 to 199
RFC	200,000 to 299,999	200 to 299	200 to 299 and 1,200 to 1,299 and 1,800 to 1,899	200 to 299
SERC	300,000 to 399,999	300 to 399	300 to 399 and 1,300 to 1,399	300 to 399
FRCC	400,000 to 499,999	400 to 499	400 to 499 and 1,400 to 1,499	400 to 499
SPP	500,000 to 599,999	500 to 599	500 to 599 and 1,500 to 1,599	500 to 599 and 800 to 899
MRO	600,000 to 699,999	600 to 699	600 to 699 and 1,600 to 1,699	600 to 699
ERCOT (future)	700,000 to 799,999	700 to 799	700 to 799 and 1,700 to 1,799	700 to 799

Data Transmittal

Transmitting data to the Southwest Power Pool can be accomplished as follows:

1. **Electronic** --- [GlobalScape](#)
2. **E-MAIL** --- SPPEngineeringModeling@spp.org

The preferred method of submittal is through the "SPP MDWG File Sharing Site", [GlobalScape](#). Include a file (excel, word, or equivalent) with description of data files submitted and which to which models they apply.

The transmitted data file should include the title of the first case and area name, followed by the changes to the first case, title of the second case and the area name, followed by the changes to the second case, etc. See Section 6-B for a sample file format. Case title lines should include the case title as in the following format examples: *04SP, *04FA, *04SH, *07SP (no spaces between characters).

Initial Run Review

After all systems prepare and submit data, an initial run is made which assembles all system data, checks for errors, and results in a solved case. The initial run shows all entered data and diagnostic messages. This data is shown first in the initial run printout. Each system should review the data changes and solved case, making corrections as needed in the subsequent runs.

1. **Area Interchange**
The area interchange report shows the area control bus, generation on the area control bus, and the net area interchange. The detail of area interchange among SPP systems is shown in the transaction data. The transaction workbook will include the NODE, Provider, and OASIS reservation number. The transaction workbook will use code DDD for transactions that do not have an OASIS reservation number. This data should be checked to ensure accuracy. Discrepancies in the transactions between reporting systems will be noted in the diagnostic messages.
2. **Tie Line Metering**
The tie line report shows the tie lines and inter-company power interchange for each system. The tie line metered end should be verified, and should reflect line loss responsibility as accurately as possible. Any changes should be coordinated with the neighboring company involved.
3. **Area Totals**
The system generation and load should be checked on the system area summary. This data should be near expected values. The detail of generation is shown in the generation summary. If load is not the expected value, individual bus loads listed in the steady-state detail report should be examined. If loads were scaled from a reference case, the scaling factor should be checked. The load power factor should also be checked as power factors change seasonally. Check Power-factor of loads. The load supplying entities for the MDWG case types will validate each load power-factor with the most current system snapshot that represents that models load level (summer peak, winter peak, light load).

4. Network

Basic to the accuracy of the steady-state model is the accuracy of the network. The layout of the system representation should be checked. Purely conjectural facilities should not be included. Planned facilities which were modeled in previous steady-state models and have since been delayed or cancelled should be removed entirely from the steady-state model. These facilities cause solution problems for some steady-state programs if left in the model with an off-line status. Planned projects, including reactive resources such as capacitor banks, are to be included in the models. These projects are to be added through MOD in accordance with the MOD Type/Status Matrix of the Web Based Steady-State Model Development Procedure Manual.

5. Review of Output

The steady-state report should be checked for the flow on major transmission lines and selected bus voltages. This check can locate unusual results, which does not necessarily mean that data is in error, but rather indicates that additional checking of the model may be appropriate.

6. Three useful reports for locating problems include:

- a. The voltage summary,
- b. The overloaded branch summary, and
- c. The generation summary.

a. Voltage Summaries

Low or high voltages may be caused by a number of factors. Shunt devices may be sized inappropriately. Capacitors should have a positive value and reactors should have a negative value. (Check the CAP/REAC column of the steady-state report). The bandwidth (difference between VSWHI and VSWLO) of switched shunt devices should be wide enough that switching one block of admittance does not move the voltage at the bus completely through the bandwidth, thus causing solution problems at the bus. It is recommended that the minimum voltage bandwidth be 4% if only switched shunts are used to regulate voltage. Switched shunts should not regulate voltage at a generator bus, nor should they be connected to the network with a zero impedance tie.

Transformer tap settings may also affect voltages. The steady-state report should be checked for tap settings. Particular attention to LTC-equipped transformers should be given to make sure the proper bus is regulated.

A tap setting of less than 1.000 on the tap bus results in an increase in voltage on the non-tap bus. A tap setting greater than 1.000 on the tap bus results in a decrease in voltage on the non-tap bus.

The inclusion of LTC regulation makes tap setting more important. With LTC-equipped transformers, fixed taps may also exist. The LTC tap range should be adjusted to compensate for the effects of fixed taps if necessary. The minimum and maximum number of ULTC and NLTC taps should comply with common industry standard practices.

Transmission line or transformer impedance errors may also affect voltages if the errors are large. See Section 6-A. for guidelines of typical transmission line or transformer impedance data.

b. **Summary of Overloaded Branches**

This summary shows each overloaded circuit, the flow on the circuit, and the normal and emergency ratings. Overloading may be caused by an incorrect rating. Both normal and emergency ratings should be given. Emergency ratings must never be less than normal ratings, though the ratings may be equal. The impedance of a circuit element or of a parallel element may also cause overloading. See Section 6-A for guidelines of typical transmission line or transformer impedance data.

c. **Generation Summary**

All buses with generation as well as all buses with voltage regulation are shown in this summary. Generators should not be modeled as unregulated buses.

The MW ratings, Mvar ratings, machine base (MBASE), and ZSOURCE must be supplied for each generator. Generator PMAX ratings should represent the net capability of each machine connected to the bus. Ratings should be adjusted seasonally in consideration of scheduled outages. The generation should be shown on the correct bus. Generation must not exceed the rating. Generator MBASE values should be equal to the nameplate MBASE rating of the unit. Each unit should be explicitly modeled and listed in the SPP Generation tab of the [Data Submittal Workbook EDST](#).

The generator workbook will be updated to include both the saturated and unsaturated impedance for each machine. Fuel types, especially wind farms, should be identified in the appropriate column.

The reactive output limits (MAX and MIN) should be realistic values as defined in SPP Planning Criteria. For generators, a general rule of thumb sets MVAR limits as:

- i. QT --- MAX = one-half of MW rating
- ii. QB --- MIN = negative one-third of MW rating

If the slack bus generation changes significantly from the input value, it indicates an error in the model data. Regulated buses are not limited to generators, but also include other equipment such as synchronous condensers and static var controllers. If the actual voltage does not match the desired voltage, a reactive limit will be reached. The desired voltage for each regulated bus should be checked seasonally.

The Generator Owners/Data Submitters of utility scale wind and solar resources shall provide an equivalent representation consisting of all collector bus(es) and the main power step-up transformer(s) from the collector bus(es) to the transmission point of interconnection (POI). Additionally, a single step-up transformer and feeder parameters for each connected generator model, from the generator terminals to a collector bus, shall be included in the equivalent representation, with wind/solar devices lumped together to represent the aggregate wind turbines or solar inverters in each collection network. The equivalent representation shall be an as-built representation (as reasonably as possible) with all transformer data reflective of manufacturer test report information. Any future changes or updates to equipment (wind turbines or solar inverters) or electrical topology shall include an updated equivalent representation to the Transmission Planner before submitting to the Planning Coordinator.

Generator facilities comprised of more than a single inverter (battery, flywheel, etc.) and other similar technology should have similar equivalent model representation. Figure 1 and Figure 2 below are illustrations provided for use as guidance for the equivalent

representations of such renewable resources; however, Figure 2 shall be the representation in the planning models.

Generator Owners/Data Submitters should coordinate with their host Transmission Owners to obtain valid SPP bus numbers for use in the equivalent representation of the generator resources. Bus names shall conform to the bus naming section of this manual. There are several industry best practice documents explaining how to represent equivalent representation of generator resources (examples: WECC Wind Power Plant Power Flow Modeling Guide and PV Plant Power Flow Modeling Guide).

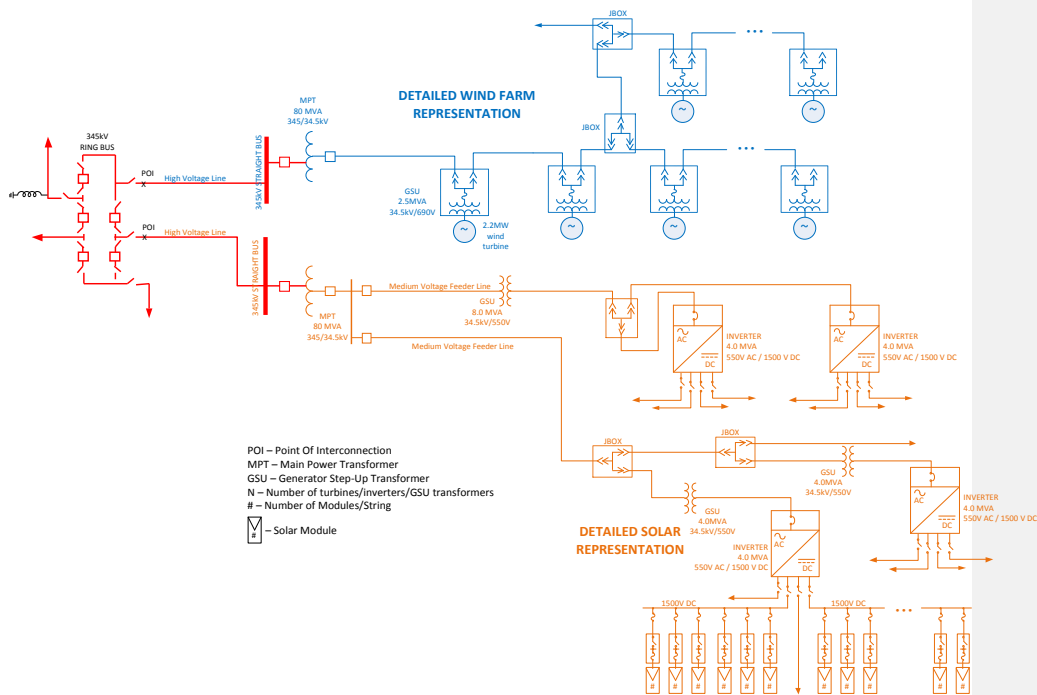
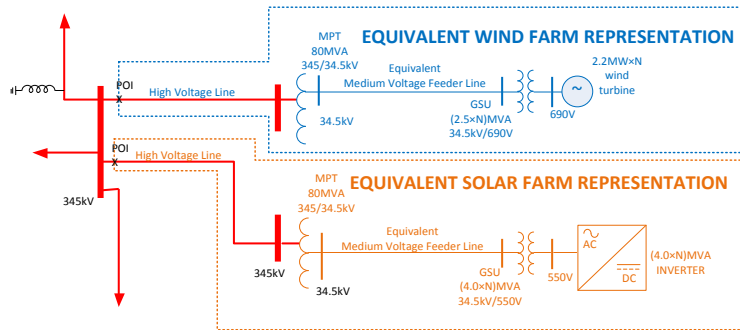

Figure 1: Detailed Wind and Solar Farm Representation (Not to be used for planning models)



POI – Point Of Interconnection
MPT – Main Power Transformer
GSU – Generator Step-Up Transformer
N – Number of turbines/inverters/GSU transformers

Figure 2: Equivalent Wind and Solar Farm Representation (Required representation for planning models)

Periodic Model Updates

After the annual update process is complete, it may become necessary to perform an update to the information contained in the model(s). Some of the reasons for updating the model(s) and the procedure for doing so are listed below.

System Impact Studies/Expansion Options Studies (Long-Term)

SPP performs transmission planning studies and assessments for various eligible customers. These model sets are developed in accordance with the SPP Planning Modeling Process and include models used for the SPP Transmission Expansion Plan, Transmission Service Studies, and Generation Interconnection Studies, which all use the data submitted to MOD as a base for model development.

MDWG Updates

At some point after the current models are extracted out of MOD some data will need to be updated to reflect pertinent changes to the system (i.e., lost or added transmission capability, lost or added generation, improved data, etc...) There are several ways of submitting changes to the steady-state models.

Two of these methods are:

1. Using the steady-state update procedure in Section 5 to update MOD.
2. Submitting a PTI, IDEV format file to perform the RDCH operation. **This method should only be used for profile changes. Each company should only submit one IDEV file per modeling pass. Under special circumstances topology changes can be submitted in an IDEV file as long as a MOD Project is submitted in MOD.**

It is imperative that any information submitted to SPP be error free and complete to avoid delays in the implementation of the changes.

The most current update to the models will always be posted on the SPP file sharing site.

Program Operation

The SPP steady-state models are created, modified, and maintained utilizing the Power Technologies, Incorporated (PTI) Power System Simulator for Engineers (PSS®E) software package. The PSS®E program is installed on SPP computer facilities located in Little Rock, Arkansas.

PTI-PSS®E Data Format

Steady-State data is input to the models from computer text data files structured in the formats described in the PSS®E Program Operation Manual Volume I, Chapter 4: Section 1.1. All data is read in "free format" with data fields separated by a **comma (not blanks)**. Each type of data category is terminated by the specification of a zero in the first field of the record with the exception of the model identification data.

Data is **added** to the SPP steady-state models as specified in these format structures for records where no corresponding component is found in the model. The **modification** of existing data in the model is accomplished using the same format structure, except that only the values that need modification are specified.

Data may also be deleted from the models. When a bus is specified for deletion, all associated data for that bus will be removed (e.g., branches, transformers, generators, and loads). **The user cannot delete a piece of equipment and then add it with new data. For example, to upgrade a bus from one voltage to another, the bus data must be modified.** Data currently in the model is used as the default value for data fields not specified in the format.

Steady-State Solution

The steady-state solution will have “Area interchange control” with the “Tie Line and Loads” option selected to meet ERAG MMWG model building requirements.

The SPP transaction workbook must not include transactions for sales to loads in other control areas if the loads are specifically identified with source control area number. If the loads in an external control area are not identified with the source control area’s number, then a transaction is necessary to schedule to this load. See example below for more details for a load that Source Area XXX has the obligation to serve:

No Transaction Needed

Source Area: XXX
Sink Area: YYY
Sink Load: XXX

Transaction Needed

Source Area: XXX
Sink Area: YYY
Sink Load: YYY

Loads may be modeled on the foreign area bus as long as it is identified as belonging to the owning area.

SPP will identify remote SPP loads in the base cases, pass 1, pass 2, and pass 3 models.

TRANSMITTED DATA FILE EXAMPLES (Refer to MOD Procedure Manual)

PTI-PSS@E SHORT CIRCUIT DATA FORMAT

The SPP Short Circuit data is included in MOD Base Case (Network) and Project data. The sequence data is comprised of positive, zero, and negative sequence data. Short circuit data that is missing in the MOD Base Case must be entered in MOD via a MOD Project with the Project Type of Network and Project Status of Update. Missing Project sequence data must be updated by applying a sequence file to the Project in MOD.

The PC (SPP) prior to presenting short circuit models to the MDWG for approval shall verify that all submitted member data has been correctly added to the short circuit models. The short circuit models shall be checked for errors and validated as usable by the PC. Any errors in the sequence data shall be brought to the attention of the Data Submitter. The usability checks shall include the PC performing data checks for missing sequence data and testing of models. The test of the models shall consist of fault analysis for three-phase, single-line-to-ground, and double-line-to-ground. The testing of the models is to ensure the models are ready for fault analysis by the SPP membership and absent of modeling errors.

For GSUs that are not retired with the associated generator, the appropriate status should be reflected in the model in order to produce accurate short circuit results.

Member submitted sequence via an IDEV file applied to a model will not be included in the next published model (Pass N or Final). The reason that sequence data is not carried over from one model set to the next model set is that sequence data is exported from MOD. Post MOD model processing IDEV files are not applied to the next model set; therefore, a MOD project which includes the sequence data must be submitted to MOD and accepted before it is included in the next MOD exported model.

SPP Data

System Abbreviations & Area Number Assignments

System Abbreviations & Area Number Assignments can be found on SPP’s website, spp.org, under the documents section of the Model Development Working Group.

SPP Members

The SPP Members are identified on the SPP Website. See the “Members” link under “About SPP” on www.SPP.org.

FORMS – Area Summary Report

	Area Name & Number: _____ Prepared By: _____ Telephone Number: _____											
POWER FLOW DATA AREA SUMMARY REPORT												
CASE												
1. Generation												
Purchases (-)/Sales (+)												
To/From Area Name												
2. Total Interchange												
3. Net Power (1-2)												
4. Load												
5. Losses												
6. Net Load (4+5)												
7. Slack Bus Generation												
8. Slack Bus Number & Name												
<i>Note:</i>												

FORMS – Steady-State Data Checklist

													Area Name & Number: _____ Prepared By: _____ Telephone Number: _____		
POWER FLOW DATA CHECKLIST															
CASE															
BUS DATA	X	X	X	X	X	X	X	X	X	X	X	X	X	X	X
Names - 12 characters															
Voltage Codes															
Power Factor															
Load - Real															
Reactive Load															
Voltage															
Fixed Shunts - Reactors															
Capacitors															
Dynamic Shunts - SVC's															
Synchronous Condensers															
Generation - Dispatch/Net															
Reactive Output															
Reactive Limits															
Regulated Voltages															
Generator Rating															
Slack Bus															
LINE DATA	X	X	X	X	X	X	X	X	X	X	X	X	X	X	X
Ratings - Normal															
Emergency															
Impedance - Resistance															
Reactance															
Charging															
Flows															
Transformers - Taps															
Tap Ranges															
Regulated Bus															
OTHER DATA	X	X	X	X	X	X	X	X	X	X	X	X	X	X	X
Net Area Interchange															
Area Transactions															
Note:															

ACRONYMS

ATC – Available Transfer Capability
CAP – Capacitor
EIA – Energy Information Act
ERAG – Eastern Interconnection Reliability Assessment Group
ERCOT – Electric Reliability Council of Texas
FPC – Federal Power Commission
IDEV – Input Device (PSS®E Dialog Input Device Selection Activity)
LTC – Load Tap Changing
MAPP – Mid-Continent Area Power Pool
MAIN – Mid-American Interpool Network
MBASE – Machine Base
MDWG – Model Development Working Group
MMWG – Multiregional Modeling Working Group
Mvar – Megavar
MW – Megawatt
NERC – North American Electric Reliability Corporation
PSS®E – Power System Simulator for Engineers
PTI – Power Technologies, Inc.
pu – Per-unit
RAWD – Raw Data
RDCH – Read Change (Command to read in and change data in PSS®E)
REAC – Reactor
SERC – Southeastern Electric Reliability Council
SPP – Southwest Power Pool, Inc.
STEP - SPP Transmission Expansion Plan
TWG – Transmission Working Group
WSCC – Western Systems Coordinating Council
ZSOURCE – Zero Impedance

NOTE – A complete listing of other SPP acronyms can be found on the SPP website at www.spp.org.
See the “Glossary and Acronyms” link under “Training”

MDWG Contact List

The MDWG Contact List can be found on SPP's website, spp.org, under the documents section of the Model Development Working Group.

SPP Model Release Guidelines

Steady-State and Short Circuit Models

SPP Base Case steady-state models and short circuit models are available to all SPP members. SPP and its members, by participating in SPP base case development, grant authority to the other participating members and SPP to release SPP Base Case steady-state models or reduced network equivalents of those models to government agencies. The public may receive models by filling out a SPP models order form and signing the appropriate SPP Confidentiality Agreement. For more information on requesting Base Case steady-state models, contact the SPP Model Contact.

Base case steady-state models of external systems, which are beyond the electrical borders of SPP and released under FERC Form 715 to government agencies, shall be the SPP models or a reduced network equivalent of the SPP models. If equivalized, such external models must be disclaimed, as equivalent representations not intended for study of the transmission systems in those external areas.

System Dynamic Data Base and Dynamic Simulation Cases

SPP Dynamic Base Case Models are available to all SPP members. SPP and its members, by participating in MMWG dynamics database (SDDB) and dynamics simulation case development, grant authority to the other participating Regions, to receive and use the SDDB and dynamics simulation cases. Regional members may send dynamics simulation cases or dynamics data to third parties provided that the third party executes a SPP confidentiality/non-disclosure agreement. The MMWG Dynamics Database (SDDB) remains the property of and is for the sole use of the MMWG participating Regions of NERC and their members.

SPP Model Contact:

Please send all general modeling questions and concerns to SPPEngineeringModeling@spp.org.

Request an SPP Map / Model

You may request an SPP Transmission Map/Model through the [Request Management System](#) by clicking on the "Order Transmission Map/Model" quick pick option.

Questions? You may find it helpful to consult [SPP Maps & Models FAQ](#).

Last Updated July 26, 2018

MDWG Case Type Set

The current MDWG Case Type Set can be found on SPP's website, spp.org, under the documents section of the Model Development Working Group.

Error Screening

The following data error screening checks will be used to check case quality:

1. Interchange and tie line data not matching the raw data will not be accepted until either the interchange data or the raw data are corrected. *
2. All CNTB errors shall be corrected. (Exceptions will be documented.)
3. All instances of mode=1 switched shunts with VHI – VLO < .005 per unit shall be corrected.
4. Any regulation by any regulating device of a bus more than one bus away, except where there is a three-winding transformer in which case no more than two buses away, shall be corrected.
5. All instances of TCUL transformers with more than 50 tap steps shall be corrected.
6. All instances of voltage controlling bandwidth less than twice the transformer tap step size shall be corrected.
7. All transmission lines 69 kV and above, transformers with a secondary voltage of 69 kV and above, and Generator Step Up (GSU) transformers shall not have overloads (loading above 100% of Rate A) in the base case. Exception: 10 year cases may have overloads.

The effect of this check will be to delay acceptance of the applicable submittal until the problem is corrected.

Dynamics Data Submittal Requirements and Guidelines

Steady-State Modeling Requirements

1. All steady-state generators, including synchronous condensers and Static VAR Compensators (SVCs) modeled as generators, shall be identified by a bus name and unit id. All other dynamic devices, such as switched shunts, relays, and HVDC terminals, shall be identified by a bus name and base kV field. The bus name shall consist of eight characters and shall be unique within the Eastern Interconnection. Any changes to these identifiers shall be minimized.
2. Where the step-up transformer of a synchronous or induction generator or synchronous condenser is not represented as a transformer branch in the steady-state cases, the step-up transformer shall be represented in the steady-state generator data record. Where the step-up transformer of the generator or condenser is represented as a branch in the steady-state cases, the step-up transformer impedance data fields in the steady-state generator data record shall be zero and the tap ratio unity. The mode of step-up transformer representation, whether in the steady-state or the generator data record, shall be consistent from case to case within a model series.
3. Where the step-up transformer of a generator, condenser, or other dynamic device is represented in the steady-state generator data record, the resistance and reactance shall be given in per unit on the generator or dynamic device nameplate MVA. The tap ratio shall reflect the actual step-up transformer turns ratio considering the base kV of each winding and the base kV of the generator, condenser or dynamic device.

4. In accordance with PTI PSS@E requirements, the Xsource value in the steady-state generator data record shall be as follows:
 - a. Xsource = X''_d for detailed synchronous machine modeling
 - b. Xsource = X'_d for non-detailed synchronous machine modeling
 - c. Xsource = should be equal to locked rotor impedance for an induction machine
 - d. Xsource = 1.0 per unit or larger for all other devices
5. Generally, SVCs should be represented in steady-state as continuously variable switched shunts rather than as generators. In iterative steady-state solutions, a generator which hits a VAR limit on solution iteration will lock at that value, but a switched shunt will move off the limit in a subsequent iteration if appropriate. PSS@E dynamic library models compatible with either representation are available. If a user model representing particular SVC and control features is to be used and that model assumes generator representation, the SVC should be represented as a generator in the steady-state.

Dynamic Modeling Requirements

1. All synchronous generator and synchronous condenser modeling and associated data shall be detailed except as permitted below. Detailed generator models consist of at least two direct axis circuits and one quadrature axis equivalent circuit. The PSS@E dynamic model types classified as detailed are GENROU, GENSAL, GENROE, GENSAE, and GENDCO.

The use of non-detailed synchronous generator or condenser modeling shall be permitted for units with nameplate ratings less than or equal to 50 MVA under the following circumstances:

 - a. Detailed data is not available because manufacturer no longer in business.
 - b. Detailed data is not available because unit is older than 1970.

The use of non-detailed synchronous generator or condenser modeling shall also be permitted for units of any nameplate rating under the following circumstances only:

 - a. Unit is a phantom or undesignated unit in a future year MMWG case.
 - b. Unit is on standby or mothballed and not carrying load in MMWG cases.

The non-detailed PSS@E model types are GENCLS and GENTRA. When complete detailed data are not available, and the above circumstances do not apply, typical detailed data shall be used to the extent necessary to provide complete detailed modeling.
2. All synchronous generators and condensers modeled in detail per Requirement II.1 shall also include representations of the excitation system, turbine-governor, power system stabilizer, and reactive line drop compensating circuitry. The following exceptions apply:
 - a. Excitation system representation shall be omitted if unit is operated under manual excitation control.
 - b. Turbine-governor representation shall be omitted for units that do not regulate frequency such as base load nuclear units, pumped storage units in pumping mode and synchronous condensers.
 - c. Power system stabilizer representation shall be omitted for units where such device is not installed or not in continuous operation.
 - d. Representation of reactive line drop compensation shall be omitted where such device is not installed or not in continuous operation.
3. All other types of generating units and dynamic devices including induction generators, static VAR compensators (SVC), high-voltage direct current (HVDC) systems, static compensators (STATCOM), wind turbines, and photovoltaic systems shall be represented by the appropriate PSS@E dynamic models.

4. All demand data shall include a load model which represents the expected dynamic behavior of the loads. Non-scalable loads greater than or equal to 10 MW are required to have a dynamic load model representation. For all other types of loads, absent detailed dynamic load models, the real portion (MW) of all demand data is converted to 100% constant current and the reactive portion (Mvar) of all demand data is converted to 100% constant admittance.
5. Standard PSS@E dynamic models shall be used for the representation of all generating units and other dynamic devices unless both of the following conditions apply:
 - a. The specific performance features of the user-defined modeling are necessary for proper representation and simulation of inter-regional dynamics, and
 - b. Standard PSS@E dynamic models cannot adequately approximate the specific performance features of the dynamic device being modeled.
6. When user-defined modeling is used, written documentation shall be supplied explaining the dynamic device performance characteristics. The documentation for all user-defined models shall be provided as a separate document and must include the characteristics of the model, including block diagrams, values and names of all model parameters, and a list of all state variables. Any benign warning messages that are generated by the model code at compilation time should also be documented.

Source code for User Models shall be submitted in the FLECS language of the current PSS@E revision, C, or FORTRAN. User models created in MATLAB/SIMULINK are not permitted because users of the SDDB cannot run them without purchase of additional software.
7. Netting of small generating units, synchronous condensers, or other dynamic devices with bus load shall be permitted only when the unit or device nameplate rating is less than or equal to 20 MVA. (Note: any unit or device which is already netted with bus load in the MMWG cases need not be represented by a dynamic model.)
8. Lumping of similar or identical generating units at the same plant shall be permitted only when the nameplate ratings of the units being lumped are less than or equal to 50 MVA. A lumped unit shall not exceed 300 MVA. Such lumping shall be consistent from case to case within a model series.
9. Where per unit data is required by a dynamic model, all such data shall be provided in per unit on the generator or device nameplate MVA rating as given in the steady-state generator data record. This requirement also applies to excitation system and turbine-governor models, the per unit data of which shall be provided on the nameplate MVA of the associated generator. The maximum and minimum power of cross compound units should be provided on the nameplate MVA of one machine in accordance with PSS@E model IEEE1 conventions.
10. Exceptions will be approved by MMWG on a case by case basis and the reason for each exception will be documented in the SDDB.

Dynamics Data Validation Requirements

1. All dynamics modeling data shall be screened according to the SDDB data screening checks.
2. All data items not passing these screening tests shall be resolved with the generator or dynamic device owner and corrected.
3. All regional data submittals to the MMWG coordinator shall have previously undergone satisfactory initialization and 20-second no-disturbance simulation

checks for each dynamics case to be developed. The procedures outlined in Section III.H* of this manual (*yet to be written) may be applied for this purpose.

Guidelines

1. Dynamics data submittals containing typical data should include documentation which identifies those models containing typical data. The CON conservation models, such as GENROA and GENSAA, which essentially copy dynamics data from one unit to another, may be useful for this purpose. When typical data is provided for existing devices, the additional documentation should give the equipment manufacturer, nameplate MVA and kV, and unit type (coal, nuclear, combustion turbine, hydro, etc.).
2. The voltage dependency of loads should be represented as a mixture of constant impedance, constant current, and constant power components (referred to as the ZIP model). The Regions should provide parameters for representing loads via the PTI PSS@E CONL activity. These parameters may be specified by area, zone, or bus. Other types of load modeling should be provided to MMWG when it becomes evident that accurate representation of interregional dynamic performance requires it.

Procedures for Submission of Dynamics Data to the MMWG Coordinator

Regional Coordinators have two options, described below, for submitting dynamics data to the MMWG Coordinator.

Dynamics Data Updates Using Excel Template

Regional dynamics data updates are incremental to the dynamics data in the previous year release of SDDB. Regional Coordinators should therefore verify that bus names and unit IDs in SDDB are consistent with those in the MMWG steady-state to be made dynamics ready.

The table below describes the various types of updates and the required data and information that should be provided on the Excel template and in a separate DYRE file.

Type of Update	Template Entries	Complete DYRE format record	Examples / Comments
Change one or more parameters of a dynamics model	Bus name, unit ID, model name, parameter name, new value	No	The voltage regulator gain is changed to the value determined by test.
Add a new model to an existing unit	No	Yes	A stabilizer is being added to a unit which did not have one.
Delete a model	Bus name, unit ID, model name	No	A stabilizer is removed.
Replace a model with another model of the same equipment group	Bus name, unit ID, model name for deleted model.	Yes for new model.	1. A DC exciter is replaced by a static exciter. 2. A classical machine model is replaced by a detailed model.
Change bus name and/or unit ID for all models of an existing unit	Old and new names; old and new unit IDs	No	
Change bus number	No	No	Maintain the same name and unit ID and the model data will follow automatically.
Add dynamic models for a new generating unit	Bus name, unit ID, in service and out of service dates, MVA base, Zsource, RPM, unit type	Yes	Same requirements whether unit is at new or existing bus.
Remove a unit and all associated models	Bus name, unit ID	No	

Complete Set of Dynamics Data

The regional dynamics data must be in the format of a PSS@E DYRE file. The data must be compatible and consistent with the MMWG steady-state selected for the dynamics cases that are being developed. One file for all cases is preferable.

MMWG Deliverables

Regional Coordinators

The Regional Coordinators will provide the following to the MMWG Coordinator(s).

1. Steady-State Cases
 - a. Data as needed to create the MMWG steady-state cases in RAWD or Saved Case format, regional representation shall be within an entire solved MMWG steady-state model in the proper PSS@E revision format
 - b. Tieline and interchange data in the specified format
 - c. IDEV files for any data changes
 - d. PSS@E formatted contingency file containing five N-1 contingencies valid for all cases in the model series.
 - e. Data Dictionary containing fields for Bus Number, 18 character PSS@E Bus Name, EIA Plant Code (U.S. only) and Non-Abbreviated Bus Name.
2. Dynamics Cases
 - a. Dynamics input data in DYRE format for new models
 - b. SDDB Excel worksheet for changes to the database
 - c. FLECS code and documentation for user defined models
 - d. Load conversion CONL file sorted by area
 - e. List of netted generation buses
 - f. Two contingency events per region in IDEV format

MMWG Coordinator(s)

The MMWG Coordinator(s) will post the following to the ERAG Web Site.

1. Steady-State Cases
 - Initialized steady state and regional contingency cases.
 - a. Steady-State RAWD case file
 - b. Conversion IDEV files
2. Dynamics Cases
 - Dynamics case input data, output files and instructions including:
 - a. Dynamics input data in DYRE format
 - b. FLECS code for user defined models
 - c. Load conversion CONL file sorted by area
 - d. Any IPLAN or PYTHON programs necessary to set up the dynamics case
3. Complete dynamics database and User Manual
4. Final reports

SECTION 2: STEADY-STATE MODELING

1. Modeling Detail – Each bus should be assigned the appropriate area, owner, and zone. All transmission lines 115 kV and above and all transformers with a secondary voltage of 115 kV and above should be modeled explicitly. Significant looped transmission less than 115 kV should also be modeled.
2. Nominal Bus Voltage – All bus voltages are expressed as a phase-to-phase voltage. All buses should have a non-zero nominal voltage. Nominal voltages of buses connected by lines, reactors, or series capacitors should be the same. The following nominal voltages are standard for AC transmission and sub-transmission in the United States and Canada and should generally be used: 765, 500, 345, 230, 161, 138, 115, 69, 46, 34.5 and 26.7 kV. In addition, significant networks exist in Canada having the following nominal voltages: 735, 315, 220, 120, 118.05, 110, 72, and 63.5 kV.
Nominal voltages of generator terminal and distribution buses less than 25 kV are at the discretion of the reporting entity.
If transformers having more than two windings are modeled with one or more equivalent center point buses and multiple branches, rather than as a 3-winding transformer model, it is recommended that the nominal voltage of center point buses be designated as 999 kV. Because this voltage is above the standard range of nominal voltages, it can easily be excluded from the range of data to be printed in steady-state output.
3. Islanded Buses – Islanded buses shall not be modeled.
4. Generator Modeling of Loads – Fictitious generators should not be used to “load net” (by showing negative generation) a model of other nonnative load imbedded in steady-state areas. It is recommended that a separate zone be used to model such loads to allow exclusion from system load calculations.
5. Zero Impedance Branches – Bus ties that are opened to represent switching during contingencies may be modeled in detail. Zero impedance branches are permitted to model bus ties using $R=0.00000 + X=0.0001$ and $B=0.00000$. These values facilitate differentiating between bus ties and other low impedance lines, utilizing the zero impedance threshold THRSZH in the PSS@E program. When connected between two voltage controlled (generator, switched shunt, or TCUL controlled), bus ties or other low impedance lines should be modeled using an impedance of $R=0.0001 + X=0.002$ and $B=0.00000$. This allows use of near-zero impedance attached to controlled buses that will be large enough to avoid significant solution problems.
6. Impedance of Branches In Network Equivalents – Where network representation has been equivalenced, a maximum cutoff impedance of 3.0 p.u. should be used.
7. Negative Branch Reactances – Except for series capacitors, negative branch reactances do not represent real devices. Their use in representing three winding transformers is obsolete. Negative branch reactances limit the selection of steady-state solution techniques and should be avoided.
8. Transformers – Effective with Revision 28 of PSS@E, off-nominal turns ratios may not be specified for branches; a block of four or five data records must be entered for each transformer. The off-nominal turns ratio in per unit, or the actual winding voltage in kilovolts, and the phase shift in degrees shall be specified for each winding. The measured impedance (resistive and inductive) between each pair of windings shall be specified: data entry options permit these to be entered in (1) per unit on system (100 MVA) base, (2) per unit on winding MVA base, or (3) load loss in watts and impedance on winding MVA base and base voltage.

9. Transformers Controlling Voltage or Reactive Power Flow – The upper and lower limits of off-nominal turns ratio and the number of tap positions available are entered for winding 1 of transformers controlling voltage or reactive power flow. Default values of 1.1, 0.9 and 33 are representative of U.S. practice. The upper and lower voltage limits are entered for transformers controlling voltage and the difference, in per unit, should be at least twice the tap step size. The upper and lower MVAR limits are entered for transformers controlling reactive power flow and these limits should differ by at least 10 MVAR. Limits should accurately represent the actual operation of automatic control devices.
10. Remote Regulation – Regulation of a bus voltage more than one bus away (not counting hidden center point buses of three winding transformers) from the regulating device should be avoided. The sign of parameter CONT determines whether the off-nominal turns ratio is increased or decreased to increase voltage at the bus whose voltage is controlled by this transformer.
11. Phase Shifting Transformers (PSTs) – Manufacturer tested capability and operational limits must be provided to SPP in order to allow corrective actions to be developed by SPP planning staff for transmission planning purposes.
PSTs will be represented in the planning models as Two-winding transformers with both windings at the same nominal voltage level. The active power flow into winding 1 is entered. The tolerance should be no less than 5 MW; i.e., a 10 MW dead band. The controlling band should be at least 10 degrees. The following characteristics should be considered by the entity submitting PST modeling data for the planning models:
 - a. Real-time operational auto or manual adjustment operation of the PST.
 - b. Real-time operational average MW flow for a particular season (e.g. average hourly MW flow is +18MW [directional based] during the Summer Peak Season, June 1 – September 30) in order to represent what is typically flowing through the PST during a particular season. This applies to PSTs that are not modeled for auto adjustment, in order to appropriately model the phase shift angle and relative MW flow, but should also consider the capability of the transformer regardless of the type of operation.
 - c. Real-time operational MW flow limits (e.g. ± 20 MW).
 - d. Real-time operational phase shift angle range (e.g. -52.9° to 31.4°).
 - e. The applicable planning model impedance table should reflect the impedance correction adjustments as the phase shift angle moves through the various angle steps.
 - f. Applicable long-term firm transmission service levels for the PST.
12. Branch and Transformer Ratings – Normal is defined as continuous ratings for system intact conditions and emergency is defined as limited duration ratings used until the system is returned to normal. Accurate normal and emergency seasonal ratings of facilities are necessary to permit proper assessment of facility loading in regional and interregional studies. Three rating fields are provided for each branch and each transformer winding. Normal and emergency ratings should be entered in the first two fields (RATEA and RATEB, respectively); use of the third rating field (RATEC) is optional. Ratings should be omitted for model elements which are part of an electrical equivalent. The rating of a branch or transformer winding should not exceed the rating of the most limiting series element in the circuit, including terminal connections and associated equipment. The emergency rating should be greater than or equal to the normal rating.
13. Generator Step-Up Transformers (GSU) – When modeled implicitly, the GSU Resistance, reactance and tap setting (all in per unit values) shall be provided along with the Generator data. Whenever modeled explicitly, a GSU shall be modeled similar to a power transformer and the GSU nominal winding voltages, impedance(s), tap ratios, minimum and maximum tap position limits, number of tap positions, regulated bus (as applicable), normal and emergency ratings and in-service status data shall be provided. GSUs may be modeled

- explicitly as deemed necessary by either the transmission owner or the Regional Reliability Organization. Their modeling should be consistent with the associated dynamics modeling of the generator. Generator step-up transformers of cross-compound units should be modeled explicitly.
14. Out-of-Service Generator Modeling – Out-of-service generators should be modeled with a STATUS equal to zero.
 15. Generator MW Limits – The generation capability limits specified for generators (P_{MIN} and P_{MAX}) should represent realistic seasonal unit output capability for the generator in that given base case. P_{MAX} should always be greater than or equal to P_{MIN}. Net maximum and minimum unit output capabilities should be used unless the generator terminal bus is explicitly modeled, the generator step up transformer is modeled as a branch, and unit load is modeled at the bus or buses from which it is supplied.
 16. Generator MVAR Limits – The MVAR limits specified for generators (Q_{MIN} and (Q_{MAX}) should represent realistic net unit output capability of the generator modeled. Q_{MAX} should always be greater than or equal to Q_{MIN}. Net maximum and minimum unit output capabilities should be given unless the generator terminal bus is explicitly modeled, the generator step up transformer is modeled as a branch, and unit load is modeled at the bus or buses from which it is supplied.
 17. Small Generators, Capacitors, and Static VAR Devices – Small generators (e.g., 10 MVA), small capacitors, and small SVCs have limited reactive capability and cannot effectively regulate transmission bus voltage. Modeling them as regulating increases solution time. Consideration should be given to modeling them as non-regulating by specifying equal values for Q_{MIN} and Q_{MAX}. If several similar machines or devices are located at a bus and there is a need to regulate with these units, they should be lumped into an equivalent to speed solution.
 18. Coordination of Regulating Devices – Multiple regulating devices (generators, switched shunt devices, tap changers, etc.) controlling the bus voltage at a single bus, or multiple buses connected by Zero Impedance Lines as described above, should have their scheduled voltage and voltage control ranges coordinated.
Also, regulated bus voltage schedules should be coordinated with the schedules of adjacent buses. Coordination is inadequate if solving the same model with and without enforcing machine regulating limits causes offsetting MVAR output changes greater than 500 MVAR at machines connected no more than two buses away.
 19. Over and Under Voltage Regulation – Regulation of voltage schedules exceeding 1.10 per unit, or below 0.90 per unit should be avoided.
 20. Flowgates – All transmission elements comprising part of one or more flowgates should be included in the data submitted by each region. A flowgate is a selected transmission element or group of elements acting as proxy for the transmission network representing potential thermal, voltage stability, rotor angle stability, and contractual system constraints to power transfer.
 21. Fixed Shunts – All fixed shunt elements at buses modeled in the steady-state should be modeled explicitly (not as loads or included with load). The status should be set to zero if the shunt is not in service. Fixed shunt elements that are directly connected to a bus should be represented as bus shunts. Fixed shunt elements that are directly connected to and switch with a branch should be represented as line shunts.
 22. Switched Shunts – Switched shunt elements at buses modeled in the steady-state should be modeled explicitly. Continuous mode modeling using a switched shunt should not be used unless it represents actual equipment (e.g. SVC or induction regulator). The number and size of switched admittance blocks should represent field conditions. The bandwidth (difference between V_{SWHI} and V_{SWLO}) of switched shunt devices should be wide enough

that switching one block of admittance does not move the voltage at the bus completely through the bandwidth, thus causing solution problems at the bus. It is recommended that the minimum voltage bandwidth be 4% if only switched shunts are used to regulate voltage. Switched shunts should not regulate voltage at a generator bus, nor should they be connected to the network with a zero impedance tie.

23. Static Var Systems – Static var elements should be modeled with accurate reactive power (leading/lagging) limits. An accurate voltage set point and equipment status, as well as any associated fixed/switched shunt equipment should also be modeled based on actual seasonal operation.
24. HVDC – All HVDC transmission facilities must be represented with a sufficiently detailed model to simulate its expected behavior.
25. Interchange Tolerances – In a solved case, the actual interchange for any area containing a Type 3 (swing) bus should be within 25 MW of the specified desired interchange value. (Note that PSS@E does not enforce the interchange deviation for areas containing Type 3 buses.)
26. Scheduled Interchange vs. Scheduled Tie Line Flows – Scheduled interchange between areas directly connected solely by ties with flows controlled to a specific schedule (PAR-controlled AC or DC) should be consistent with the PAR or DC scheduled flows.

Causes of Non-convergence and Problems in Merged Base Case Models

Causes of Non-convergence

1. A line whose impedance is very small as compared to that of a line connected in series with it.
(Solution: If possible, add impedance of short and long series-connected lines and represent as one line.)
2. Tie lines are missing because they were not picked up by model creation or tie lines are connected incorrectly.
3. An impedance or susceptance value whose magnitude is extremely large. A decimal point may have been misplaced, or large cutoff impedance was specified during equivalencing.
4. A system's regulating (slack) bus is in a different system. This is probably due to an incorrect data entry in changing a model.
5. An isolated system (island) has been inadvertently created. Voltage phase divergence will be flagged immediately and the program will stop calculating after the first iteration.
6. Unrealistic tap changing transformer tap limits.
7. Radial system is very large.
8. Poor voltage regulation such as:
 - a. Unequal voltage schedules at generating units connected by a low impedance line.
 - b. Regulation of a radial line at both ends at unequal voltages.
 - c. (Solution: Do not regulate a radial bus; hold MVAR output of a radial bus constant at the value obtained in last iteration.)
 - d. Conflicting voltage regulation.
 - e. Unreasonably small voltage range for switched shunts.
 - f. Remote regulation of more than one bus away.
9. Over-equivalencing of outside Regions in regional base case models.
10. Not solvable from flat start.
11. Fictitious regulation of buses.
12. Extremely low voltage schedules.

13. Not following the approved MMWG sign convention for phase shifters (see page 3 of this **Appendix**) or not adhering to minimum MW tolerance for phase-shifting-under load transformers.
14. Zero or very low reactance branches. Minimum reactance = 0.0001 per unit.
15. Inconsistent representation of delta-wye transformers, typically by two companies interconnected at both voltage levels.

Problems

1. Duplicate bus names in an area(s).
2. The data will not permit steady-state calculations, such as:
 - a. Zero voltage regulation, resulting in division by zero. Notify Regional Coordinator.
 - b. Interchange does not net to zero. Save the data but do not calculate until the Coordinator has given instructions for correcting the data.
 - c. High R/X ratios in equivalent area causing non-convergence. Delete line or reduce ratio.
3. Missing tie lines. These tie lines may or may not be in the base case model. The program flags the tie lines as missing because of its tie line checking routine. A review of the data dump will verify the inclusion of a tie line if it is included and has been flagged as missing. Likewise, the validity of the error message will be verified by a review of the data dump.
4. Phase Shifting Transformers
 - a. The first-named bus in the branch data is taken as the "From" bus and the second-named bus is taken as the "To" bus. The "From" bus is also taken as the tapped bus.
 - b. If phase shift angle is specified in CDF as positive, $\alpha < \beta$.
 - c. Assuming α and β stay relatively constant for small changes, an increase in this positive phase shift angle will tend to change the voltage phase angle of Bus A in a lagging direction relative to that for Bus B. This causes an incremental increase in real power flow in the direction of B to C regardless of the direction of the initial real power flowing through the transformer.
 - d. A desired positive real power flow into the phase shifting transformer at the "From" bus or tapped bus is specified with positive real power limits.
 - e. The "Controlled Bus" specified should be the same as the tapped bus to be consistent and avoid confusion.

Note: The PTI PSS@E steady-state program currently being used by AEP to process MMWG models requires the above convention. Therefore, it is desirable that all phase shifter models sent to AEP conform to this convention. If the data submitted does not conform to the above convention, AEP must be notified so that appropriate corrections can be made.

SECTION: PROCEDURES FOR INITIALIZATION AND NO-DISTURBANCE CHECKS OF LIBRARY DYNAMICS CASES

Note: PSS®E activities relevant to the following steps are shown in brackets.

1. Create a converged load flow case with as few limit violations and questionable data items as possible.
 - a. Solve the case after each set of major changes [FNLS, FDNS, SOLV, or MSLV] and save it to minimize rework if a change has unintended consequences. If all of the following constraints are satisfied, convergence within tolerance, even from a flat start, should not take more than the default number of iterations. However, there is usually no reason to use a flat start if the case being updated was solved.
 - b. Generator checks using a list of all data to spot unrealistic, typically default, generator data values. [LIST, option 5] There is no checking activity listing only machines having suspect values of the following
 - i. Machine MVA on the default base of 100. Although models will work if all load flow and dynamic model parameters are entered on this basis, limit checks will not work correctly.
 - ii. Source impedance of 1.0 p.u. on machine MVA base. This value is substantially higher than normal for synchronous machines.
 - iii. Source impedances equal to or less than zero. These will cause generator conversion to fail.
 - iv. Real and/or reactive power limits of +9999 or -9999.
 - c. Checks which report abnormal values
 - i. Branch flows exceeding normal ratings. [RATE or OLTL and OLTR]
 - ii. Bus voltages below 0.95 p.u. except in the case of generator terminal voltage buses connected to the transmission bus by a step-up transformer with a tap ratio significantly off nominal. [VCHK]
 - iii. Overloaded generators. [GEOL]. Note that this activity checks machine output against the machine MVA base, MBASE, not against PMAX, PMIN, QMAX, and QMIN.
 - iv. Branches with extreme impedances or tap ratios [BRCH]. Suggested options are:
 - a) Small impedance. Note that very small impedances can be treated as zero impedance ties by selection of parameter THRSZ and these will not be a problem.
 - b) Negative reactance. These are typically found in Y representations of three winding transformers. Solution activity SOLV may not be used on cases containing such branches and MSLV may not be used if they are present at a Type 2 or 3 (generator) bus.
 - c) Charging. Values exceeding the default upper check limit (5.0 p.u.) are normal on long EHV lines but others should be checked. Negative values are occasionally used for magnetizing impedance on transformers but this usage is not recognized in the PSS®E Program Operation Manual.

- d) Parallel transformers. Minor tap ratio differences may simply reflect field conditions, but differences exceeding one step should be checked to guard against inadvertent errors.
 - e) High tap ratios.
 - f) Low tap ratios.
- d. Interactive checks: the user is asked to enter new value(s) for each exception, or hit "carriage return" for no change.
- i. Generators dispatched outside their real power limits [SCAL]. Scaling areas or zones should be used cautiously if generators having default PMAX (+9999) and PMIN (-9999) limits are present.
 - ii. Inconsistent targets at a bus whose voltage is controlled by two or more system elements: local generation, switched shunts, and voltage controlling transformers. [CNTB]. There is a tendency not to recognize different summer and winter operating strategies where appropriate.
 - iii. Questionable voltage or flow controlling transformer parameters. [TPCH]
 - iv. Buses in "islands" not containing a system swing bus. [TREE]. Note that there can be multiple islands each of which does contain a system swing bus, with DC links connecting them.
2. To confine the initialization to a subset of the original load flow, for instance the areas comprising one region, proceed as follows.
- a. Create a raw data file containing only the area(s) of interest. [RAWD, AREA]
 - b. Read in the raw data file just created. [READ]
 - c. If no system swing bus is in the area kept, change the type of a generator bus from 2 to 3 to make it the system swing bus. [CHNG]
 - d. Locate any islands created by the subsetting operation and either connect or drop them. [TREE].
 - e. Replace flows on tie lines severed by the subsetting operation with equivalent loads (positive for flows out, negative for flows in). [BGEN]
3. Net generation with load at any buses where a generator(s) exists for which no dynamic models are available. [GNET].
4. Convert the generators in the load flow [CONG], solve, [ORDR, FACT, TYSL] and save converted case.[SAVE]
5. From the dynamics entry point, read in the dynamic model data file [DYRE] (Load flow case must also be in memory.)
- a. Specify CONEC, CONET, and COMPILE files.
 - b. It is highly desirable to include a SYSANG model in the DYRE file, although this makes it mandatory to recompile even if no user models are included. This model provides six monitoring output channels, which can be used to scan a no-disturbance simulation for stability without attempting to select individual machines to monitor.
6. Concatenate FLECS code for user models onto CONEC or CONET files.
7. Compile.
8. Execute CLOAD4.
9. Restart from the dynamics entry point, this time using "user dynamics".
- a. Read converted load flow [CASE].
 - b. Read in the dynamic data file [DYRE]
 - c. Specify channels to record appropriate states and variables as simulation outputs [CHAN]. Include SYSANG variables if this model was included in the dynamics data file as suggested above.
 - d. Check consistency of dynamic models [DYCH, option 1].

- e. Initialize dynamic simulation [STRT]. The output of this activity may have several important parts and it is desirable to keep a log file for reference while debugging.
 - i. Warning messages for
 - a) Generators in the load flow for which there is no active machine model.
 - b) Models, usually of excitation systems or governors, initialized out of limits.
 - c) The number of iterations required to initialize the initial-conditions steady-state.
 - ii. A tabulation of conditions at each online machine
 - a) Terminal voltage
 - b) Exciter output voltage
 - c) Real and reactive power output
 - d) Power factor
 - e) Machine angle in degrees
 - f) Direct and quadrature axis currents on machine base.
 - iii. A diagnosis of initial conditions, either
 - a) "Initial conditions check OK", or
 - b) A listing of suspect initial conditions generally states whose time derivative is not "small" (relative to the value of the state). These may be caused by inconsistencies between the real and reactive power scheduled for a unit by the load flow (including automatic changes in reactive power to hold bus voltage at a target level) or by parameter errors.
 - iv. For models flagged in steps i) through iii), consider using activity [DOCU] to identify parameters which may be causing problems. This activity will also give the automatically calculated values of exciter model parameters, which are derived if the corresponding parameters, as read in, are 0. Other warnings may indicate errors in the steady-state model.
 - f. Modify model parameters or the load flow as appropriate and repeat steps up to this point until there are no warning messages nor suspect initial conditions.
10. Record a snapshot [SNAP] of dynamic state values prior to application of any disturbance or simulation of any time period.
 11. Simulate undisturbed operation [RUN] for at least 20 seconds. Printing the convergence monitor [RUN,CM] can indicate where problems are, but considerably increases the amount of output.
 12. Stop simulation. Review output values in tabular and/or graphical form.
 13. Validate exciter model response to a step change in set point. [ESTR] and [ERUN]. Field voltage and terminal voltage will be output for each exciter model and may be reviewed in tabular or graphical form. Satisfactory response is indicated if the terminal voltage settles to the specified value within a few seconds, if the field voltage is reasonable, and the response is free of
 - a. Excessive overshoot
 - b. Sustained oscillations
 - c. High frequency noise (may be caused by using too long a simulation time step.)
 - d. Unexpected discontinuities in the output variables or their derivatives (except IEEE Type 4 "non-continuous" regulator models).
 14. Validate governor model response to a step change. [GSTR] and [GRUN]. Mechanical power and speed deviation will be output for each shaft where a governor model is present and may be reviewed in tabular or graphical form. Models of cross-compound unit governors specify two machines so four output variables are used. Steam or combustion turbine unit governors may require up to 20 seconds to attain

equilibrium, and hydro units even longer, even if they are well tuned. Satisfactory response is indicated if speed deviation settles to approximately $(-K) = (-1/R)$, mechanical power to $(1-1/K)$ times the specified value, and the response variables are free of excessive overshoot or sustained oscillations.

Compliance

1. MDWG [Model Development Procedure Manual](#)
Note: The latest document can be found on SPP.org
2. MDWG [Power flow, Short Circuit, and Dynamic model schedule and list](#)
Note: The latest document can be found on SPP.org
3. Data Submittal Forms (This is a separate document)
Note: The latest document is posted with every model set
4. MDWG Procedure for late or no data submittal (FUTURE)

SECTION: APPENDIX I MASTER TIE LINE FILE DATA FIELDS

Branch Data Fields

In Service Date,
Out Service Date,
From Region Name,
From Area#,
From Area Name,
From Bus#,
From Bus Name,
From Bus kV,
To Region Name,
To Area#,
To Area Name,
To Bus#,
To Bus Name,
To Bus kV,
Metered End (F,T),
CKT,
R,
X,
B,
Summer Rating A,
Summer Rating B,
Summer Rating C,
Winter Rating A,
Winter Rating B,
Winter Rating C,
GI (pu),
BI (pu),
GJ (pu),
BJ (pu),
STATUS (0,1),
LEN (mi),
Owner 1,
Fraction 1,
Owner 2,
Fraction 2,
Owner 3,
Fraction 3,
Owner 4,
Fraction 4

Two Winding Transformer Data Fields

In Service Date,
Out Service Date,
From Bus Region Name,
From Bus Area#,
From Bus Area Name,
From Bus Number,
From Bus Name,
From Bus kV,
To Bus Region Name,
To Bus Area#,
To Bus Area Name,
To Bus Number,
To Bus Name,
To Bus kV,
Tapped Side,
CKT,
CW,
CZ,
CM,
MAG1,
MAG2,
Metered Side,
NAME,
STATUS (0,1),
Owner 1,
Fraction 1,
Owner 2,
Fraction 2,
Owner 3,
Fraction 3,
Owner 4,
Fraction 4,
R1-2,
X1-2,
SBase1-2,
WindV1,
NomV1,
Ang1,
Summer Rating A1,
Summer Rating B1,
Summer Rating C1,
Winter Rating A1,
Winter Rating B1,
Winter Rating C1,

Two Winding Transformer Data Fields - continued

COD1,
Volt Control Bus Region Name,
Volt Control Bus Area Number,
Volt Control Bus Area Name,
Volt Control Bus Number (CONT1),
Volt Control Bus Name,
Volt Control Bus kV,
RMA1,
RMI1,
VMA1,
VMI1,
NTP1,
TAB1,
CR1,
CX1,
WindV2,
NomV2

Three Winding Transformer Data Fields

In Service Date,
Out Service Date,
Winding 1 Region Name,
Winding 1 Area#,
Winding 1 Area Name,
Winding 1 Bus#,
Winding 1 Bus Name,
Winding 1 Bus kV,
Winding 2 Region Name,
Winding 2 Area#,
Winding 2 Area Name,
Winding 2 Bus#,
Winding 2 Bus Name,
Winding 2 Bus kV,
Winding 3 Region Name,
Winding 3 Area#,
Winding 3 Area Name,
Winding 3 Bus#,
Winding 3 Bus Name,
Winding 3 Bus kV,
CKT,
CW,
CZ,
CM,
MAG1,
MAG2,
NMETR(1,2,3),
NAME,
STATUS(0,1),
Owner 1,
Fraction 1,
Owner 2,
Fraction 2,
Owner 3,
Fraction 3,
Owner 4,
Fraction 4,
R1-2,
X1-2,
SBase1-2,
R2-3,
X2-3,
SBASE2-3,
R3-1,

Three Winding Transformer Data Fields - continued

X3-1,
SBASE3-1,
VMSTAR,
ANSTAR,
WindV1,
NomV1,
Ang1,
Summer Rating A1,
Summer Rating B1,
Summer Rating C1,
Winter Rating A1,
Winter Rating B1,
Winter Rating C1,
COD1,
Control Bus 1 Region,
Control Bus 1 Area Number,
Control Bus 1 Area Name,
Control Bus #(CONT1),
Control Bus Name,
Control Bus KV,
RMA1,
RMI1,
VMA1,
VMI1,
NTP1,
TAB1,
CR1,
CX1,
WindV2,
NomV2,
Ang2,
Summer Rating A2,
Summer Rating B2,
Summer Rating C2,
Winter Rating A2,
Winter Rating B2,
Winter Rating C2,
COD2,
Control Bus 2 Region,
Control Bus 2 Area Number,
Control Bus 2 Area Name,
CONT2,
Control Bus 2 Name,
Control Bus 2 KV,
RMA2,

Three Winding Transformer Data Fields - continued

RMI2,
VMA2,
VMI2,
NTP2,
TAB2,
CR2,
CX2,
WindV3,
NomV3,
Ang3,
Summer Rating A3,
Summer Rating B3,
Summer Rating C3,
Winter Rating A3,
Winter Rating B3,
Winter Rating C3,
COD3,
Control Bus 3 Region,
Control Bus 3 Area Number,
Control Bus 3 Area Name,
CONT3,
Control Bus 3 Name,
Control Bus 3 KV,
RMA3,
RMI3,
VMA3,
VMI3,
NTP3,
TAB3,
CR3,
CX3

Two Terminal DC Tie Data Fields

In Service Date,
Out Service Date,
I,
MDC,
RDC,
SETVL,
VSCHD,
VCMOD (1,0),
RCOMP,
DELTI,
METER (R,I),
DCVMIN,
CCCITMX,
CCCACC,
IPR REGION NAME,
IPR AREA#,
IPR AREA NAME,
IPR Bus#,
IPR BUS NAME,
IPR BUS Kv,
NBR,
ALFMX,
ALFMN,
RCR,
XCR,
EBASR,
TRR,
TAPR,
TMXR,
TMNR,
STPR,
ICR REGION NAME,
ICR AREA#,
ICR AREA NAME,
ICR BUS#,
ICR BUS NAME,
ICR BUS kV,
IFR REGION NAME,
IFR AREA#,
IFR AREA NAME,
IFR BUS#,
IFR BUS NAME,
IFR BUS KV,
ITR REGION NAME,
ITR AREA#,

Two Terminal DC Tie Data Fields

ITF AREA NAME,
ITR BUS#,
ITR BUS NAME,
ITR BUS KV,
IDR,
XCAPR,
IPI REGION NAME,
IPI AREA#,
IPI AREA NAME,
IPI Bus#,
IPI BUS NAME,
IPI BUS Kv,
NBI,
GAMMX,
GAMMN,
RCI,
XCI,
EBASI,
TRI,
TAPI,
TMXI,
TMNI,
STPI,
ICI REGION NAME,
ICI AREA#,
ICI AREA NAME,
ICI BUS#,
ICI BUS NAME,
ICI BUS kV,
IFI REGION NAME,
IFI AREA#,
IFI AREA NAME,
IFI BUS#,
IFI BUS NAME,
IFI BUS KV,
ITI REGION NAME,
ITI AREA#,
ITI AREA NAME,
ITI BUS#,
ITI BUS NAME,
ITI BUS KV,
IDI,
XCAPI

- Notes:** (1) The data formats must be compatible with PSS®E input requirements.
(2) The in-service and out-of-service dates will be expressed as mm/dd/yyyy.

SECTION: APPENDIX II NUMBER RANGE ASSIGNMENTS FOR ERAG MMWG STEADY-STATE DATA

Region	Bus Numbers	Area Numbers	Zone Numbers	Owner Numbers
Entire System	100,000 - 899,999	100 to 899	100 to 1,899	100 to 1,199
NPCC	100,000 to 199,999	100 to 199	100 to 199 and 1,100 to 1,199	100 to 199
RFC	200,000 to 299,999	200 to 299	200 to 299 and 1,200 to 1,299 and 1,800 to 1,899	200 to 299
SERC	300,000 to 399,999	300 to 399	300 to 399 and 1,300 to 1,399	300 to 399
FRCC	400,000 - 499,999	400 to 499	400 to 499 and 1,400 to 1,499	400 to 499
SPP	50,000 to 599,999	500 to 599	500 to 599 and 1,500 to 1,599	500 to 599 and 800 to 899
MRO	600,000 to 699,999	600 to 699	600 to 699 and 1,600 to 1,699	600 to 699
ERCOT (future)	700,000 to 799,999	700 to 799	700 to 799 and 1,700 to 1,799	700 to 799

1 Area or zone number 1 is sometimes used as a default when the number is omitted by mistake. Its use to number an actual area should be avoided.

SECTION: APPENDIX III UTILIZED IMPEDANCE CORRECTION TABLES

Table Number	Tap or Angle	1 Factor	Tap or Angle	2 Factor	Tap or Angle	3 Factor	Tap or Angle	4 Factor	Tap or Angle	5 Factor	Tap or Angle	6 Factor	Tap or Angle	7 Factor	Tap or Angle	8 Factor	Tap or Angle	9 Factor	Tap or Angle	10 Factor	Tap or Angle	11 Factor
1	-60	1	-36	0.358	-24.4	0.192	-12.4	0.054	-8.3	0.024	0	0.01	8.3	0.024	12.4	0.054	24.4	0.192	36	0.358	60	1
2	-70	1	-43	0.78	-32	0.85	0	0.5	32	0.85	43	0.78	70	1	0	0	0	0	0	0	0	0
3	-180	1	-150	0.5	0	0.5	150	0.5	180	1	0	0	0	0	0	0	0	0	0	0	0	0
4	-152	1	-121.5	0.625	-85.4	0.372	-42.2	0.217	0	0.157	42.2	0.217	85.4	0.372	121.5	0.625	152	1	0	0	0	0
8	-40	1.848	-30	1.468	0	1	30	1.538	40	1.83	0	0	0	0	0	0	0	0	0	0	0	0
10	-25	1.995	0	1	25	1.995	0	0	0	0	0	0	0	0	0	0	0	0	0	0	0	0
11	-25	1.995	0	1	25	1.995	0	0	0	0	0	0	0	0	0	0	0	0	0	0	0	0
12	-40	1.66	-29.5	1.331	-25.1	1.228	-20.6	1.145	0	1	20.6	1.145	25.1	1.228	29.5	1.331	40.1	1.66	0	0	0	0
13	-40	1.849	-30	1.402	-20	1.196	-10	1.045	0	1	10	1.045	20	1.161	30	1.366	40	1.741	0	0	0	0
16	-30	1.913	0	1	30	1.913	0	0	0	0	0	0	0	0	0	0	0	0	0	0	0	0
17	-47	6.34	-41.7	5.44	-33.3	4	-27.5	3.06	-18.5	2	0	1	18.5	1.76	27.5	3.278	33.3	3.643	41.7	5.25	47	1
18	-40	2.31	0	1	40	2.31	0	0	0	0	0	0	0	0	0	0	0	0	0	0	0	0
19	-40	7.35	-30	4.85	-20	2.9	-10	1.6	0	1	10	1.6	20	2.9	30	4.85	40	7.35	0	0	0	0
20	0.937	1.641	1	1	1.03	1.02	1.1	1.427	0	0	0	0	0	0	0	0	0	0	0	0	0	0
21	0.889	0.575	1.04	1	1.2	2.89	0	0	0	0	0	0	0	0	0	0	0	0	0	0	0	0
22	0.8	1.563	0.85	1.384	0.9	1.235	0.95	1.108	1	1	1.05	0.907	1.1	0.826	1.15	0.756	1.2	0.694	1.25	0.64	1.3	1
23	-10	1	5	0.655	20	1.449	0	0	0	0	0	0	0	0	0	0	0	0	0	0	0	0
25	-60	9.2	-46.38	4.69	-32.3	1.87	-20	1	0	1	18	1	32.3	3	46.38	5.54	60	9.2	0	0	0	0
31	-15	2.076	0	1	15	2.076	0	0	0	0	0	0	0	0	0	0	0	0	0	0	0	0
32	-15	1.62	0	1	15	1.62	0	0	0	0	0	0	0	0	0	0	0	0	0	0	0	0
33	-5.7	2.061	0	1	5.7	2.061	0	0	0	0	0	0	0	0	0	0	0	0	0	0	0	0
34	-10	1.782	0	1	10	1.782	0	0	0	0	0	0	0	0	0	0	0	0	0	0	0	0
35	-30	1.65	0	1	30	1.65	0	0	0	0	0	0	0	0	0	0	0	0	0	0	0	0
37	-15	2.076	0	1	15	2.076	0	0	0	0	0	0	0	0	0	0	0	0	0	0	0	0
40	-40	1	-35	0.75	-25	0.6	-12.5	0.55	-7.5	0.52	0	0.5	7.5	0.52	12.5	0.55	25	0.6	35	0.75	40	1
42	-42.5	1.784	-32.6	1.497	-22	1.26	-11.1	1.07	0	1	11.1	1.05	22	1.193	32.6	1.443	42.5	1.782	0	0	0	0
44	-52.9	1.9024	-43.6	1.6768	-33.7	1.4512	-23.2	1.2256	-12.3	1	-1.2	1.1385	9.9	1.2769	20.9	1.4154	31.4	1.5539	0	0	0	0

SECTION: APPENDIX IV

UTILIZED DC LINES

<u>DC Line Number</u>	<u>Region</u>	<u>Name</u>		<u>DC Line Number</u>	<u>Region</u>	<u>Name</u>
1	MRO			26	NPCC	
2	MRO			27	NPCC	
3	MRO			28	NPCC	
4	MRO			29	NPCC	
5	MRO			30	RFC	
6	MRO			31	RFC	
7	MRO			32	Unused	
8	MRO			33	Unused	
9	MRO			34	Unused	
10	MRO			35	Unused	
11	NPCC			36	NPCC	
12	NPCC			37	NPCC	
13	NPCC			38	NPCC	
14	NPCC			39	NPCC	
15	NPCC			40	Unused	
16	NPCC			41	SPP	
17	NPCC			42	SPP	
18	NPCC			43	SPP	
19	NPCC			44	SPP	
20	NPCC			45	SPP	
21	NPCC			46	MRO	
22	NPCC			47	MRO	
23	NPCC			48	MRO	
24	NPCC			49	MRO	
25	NPCC			50	Unused	

SECTION: APPENDIX V SYSTEM CODES FOR USE IN ERAG MMWG STEADY-STATE DATA

NPCC – Northeast Power Coordination Council

<u>Area #</u>	<u>ID</u>	<u>System</u>
101	ISO-NE	ISO New England
102	NYISO	New York ISO
103	IESO	Independent Electric System Operator
104	TE	TransEnergie
105	NB	New Brunswick Power
106	NS	Nova Scotia Power
107	CORNWALL	Cornwall

RFC – Reliability First Corporation

<u>Area #</u>	<u>ID</u>	<u>System</u>
201	AP	Allegheny Power
202	FE	FirstEnergy
205	AEP	American Electric Power
206	OVEC	Ohio Valley Electric Corporation
207	HE	Hoosier Energy Rural Electric Cooperative, Inc.
208	DEM	Duke Energy Midwest
209	DAY	Dayton Power & Light Company
210	SIGE	Southern Indiana Gas & Electric Company
215	DLCO	Duquesne Light Company
216	IPL	Indianapolis Power & Light Company
217	NIPS	Northern Indiana Public Service Company
218	METC	Michigan Electric Transmission Co., LLC
219	ITCT	International Transmission Company
220	IPRV	Illinois Power- Riverside Plant
222	CE	Commonwealth Edison
225	PJM	PJM 500 kV System
226	PENELEC	Pennsylvania Electric Company
227	METED	Metropolitan Edison Company
228	JCP&L	Jersey Central Power & Light Company
229	PPL	PPL Electric Utilities
230	PECO	PECO Energy Company
231	PSE&G	Public Service Electric & Gas Company
232	BG&E	Baltimore Gas & Electric Company
233	PEPCO	Potomac Electric Power Company
234	AE	Atlantic Electric
235	DP&L	Delmarva Power & Light Company
236	UGI	UGE Utilities, Inc.
237	RECO	Rockland Electric Company
295	WEC	Wisconsin Electric Power Company (ATC)
	ESE	Edison Sault Electric (American Transmission Company - ATC)

SERC – SERC Reliability Corporation

<u>Area #</u>	<u>ID</u>	<u>System</u>
314	BREC	Big Rivers Electric Corporation
320	EKPC	East Kentucky Power Cooperative
330	AECI	Associated Electric Cooperative Inc.
331	BCA	Batesville
332	LAGN	Louisiana Generating Company
333	CWLD	Columbia, MO Water and Light
334	WESTMEMP	West Memphis
335	CONWAY	Conway
336	BUBA	Benton Utilities Balancing Authority
337	PUPP	Panda Union Power Partners
338	DERS	City of Ruston
339	DENL	City of North Little Rock
340	CPLE	Carolina Power & Light Company – East
341	CPLW	Carolina Power & Light Company – West
342	DUKE	Duke Energy Carolinas
343	SCEG	South Carolina Electric & Gas Company
344	SCPSA	South Carolina Public Service Authority
345	DVP	Dominion Virginia Power
346	SOUTHERN	Southern Company
347	TVA	Tennessee Valley Authority
349	SMEPA	South Mississippi Electric Power Association
350	AEC	Alabama Electric Cooperative
351	EES	Entergy Electric System
352	YAD	APGI – Yadkin Division
353	SEHA	Hartwell - SEPA
354	SERU	Russell - SEPA
355	SETH	Thurmond – SEPA
356	AMMO	Ameren Missouri
357	AMIL	Ameren Illinois
360	CWLP	City of Springfield (IL) Water Light & Power
361	SIPC	Southern Illinois Power Cooperative
362	EEL	Electric Energy Incorporated
363	LGEE	E.ON.US

FRCC Florida Reliability Coordination Council

<u>Area #</u>	<u>ID</u>	<u>System</u>
401	FPL	Florida Power & Light
402	PEF	Progress Energy Florida
403	FTP	Fort Pierce Utility Authority
404	GVL	Gainesville Regional Utility
405	HST	City of Homestead
406	JEA	Jacksonville Electric Authority
407	KEY	City of Key West
409	LWU	City of Lake Worth Utility
410	NSB	Utilities Commission of New Smyrna Beach
411	FMPP	Florida Municipal Power Pool
412	SEC	Seminole Electric Cooperative
414	STK	City of Starke
415	TAL	City of Tallahassee
416	TECO	Tampa Electric Company
417	FMP	FMPA / City of Vero Beach
418	NUG	Non-Utility Generators
419	RCU	Reedy Creek Energy Services, INC.
421	TCEC	Treasure Coast Energy Center
426	OSC	Osceola at Holopaw (PEF)
427	OLEANDER	Oleander IPP at Brevard (FPL)
428	CALPINE	Calpine at Recker (TECO)
431	VAN	IPS Avon Park at Vandolah (PEF)
433	HPS	Hardee Power Station (TECO)
436	DESOTOGEN	Desoto Generation IPP at Whidden (FPL)
438	IPP-REL	Reliant at Indian River (FMPP)

SPP – Southwest Power Pool, Inc.

<u>Area #</u>	<u>ID</u>	<u>System</u>
502	CELE	Central Louisiana Electric Company
503	LAFAL	Lafayette Utilities
504	LEPA	Louisiana Energy and Power Authority
505	ALEX	City of Alexandria
507	RAYB	Rayburn Country Electric Cooperative
508	NTEC	North Texas Electric Cooperative
509	SRGT	Sam Rayburn G&T
511	AREC	Arkansas Electric Cooperative
513	CLWL	City of Clarksdale
514	MEAM	Municipal Energy Agency of Mississippi
515	SWPA	Southwestern Power Administration
520	AEPW	American Electric Power
522	KAMO	Kamo Electric Cooperative
523	GRDA	Grand River Dam Authority
524	OKGE	Oklahoma Gas and Electric Company
525	WFEC	Western Farmers Electric Cooperative
526	SPS	Southwestern Public Service
527	OMPA	Oklahoma Municipal Power Authority
531	MIDW	Midwest Energy
534	SUNC	Sunflower Electric Cooperative
536	WERE	Westar
537	SIKE	City of Sikeston, Missouri
539	WEPL	Westplains Energy
540	MIPU	Missouri Public Service Company
541	KAPL	Kansas City Power and Light Company
542	KACY	Board of Public Utilities
544	EMDE	Empire District Electric Company
545	INDN	City of Independence
546	SPRM	City Utilities of Springfield

MRO – Midwest Reliability Organization

<u>Area #</u>	<u>ID</u>	<u>System</u>
600	XEL	Xcel Energy North
	MUNI	Municipal data from Xcel Energy
	MMPA	MMPA Municipal data from Xcel Energy
	CMPA	CMPA Municipal data from Xcel Energy
608	MP	Minnesota Power & Light
613	SMPA	Southern Minnesota Municipal Power Association
615	GRE	Great River Energy
620	OTP	Otter Tail Power Company
627	ALTW	Alliant Energy West
633	MPW	Muscatine Power & Water
635	MEC	MidAmerican Energy
	CBPC	CBPC Municipal data from MEC
	RPGI	RPGI Municipal data from MEC
	IAMU	IAMU Municipal data from MEC
	MMEC	MEC Municipal data from MEC (AMES,CFU, etc.)
640	NPPD	Nebraska Public Power District
	MEAN	Municipal Energy Agency of Nebraska (NPPD)
	GRIS	Grand Island (NPPD)
645	OPPD	Omaha Public Power District
650	LES	Lincoln Electric System, NE
652	WAPA	Western Area Power Administration
	MPC	Minnkota Power Cooperative, Inc.
	BEPC	Basin Electric Power Cooperative
	NWPS	Northwestern Public Service
	MRES	Missouri River Energy Services
661	MDU	Montana-Dakota Utilities Co.
667	MHEB	Manitoba Hydro
672	SPC	Saskatchewan Power Co.
680	DPC	Dairyland Power Cooperative
	WPPI	Wisconsin Public Power Inc.
694	ALTE	Alliant Energy East (ATC)
696	WPS	Wisconsin Public Service Corporation (ATC)
	CWP	Consolidated Water Power Company (ATC)
	MEWD	Marshfield Electric and Water Company (ATC)
	MPU	Manitowoc Public Utilities (ATC)
697	MGE	Madison Gas and Electric Company (ATC)
698	UPPC	Upper Peninsula Power Company (ATC)

ERCOT & WECC

<u>Area #</u>	<u>ID</u>	<u>System</u>
700		ERCOT Electric Reliability Council of Texas, Inc.
800		WECC Western Electricity Coordinating Council

SECTION: APPENDIX VI

MOD-032-1 – ATTACHMENT 1

The table, below, indicates the information that is required to effectively model the interconnected transmission system for the Near-Term Transmission Planning Horizon and Long-Term Transmission Planning Horizon. Data must be shareable on an interconnectionwide basis to support use in the Interconnection-wide cases. A Planning Coordinator may specify additional information that includes specific information required for each item in the table below. Each functional entity¹ responsible for reporting the respective data in the table is identified by brackets “[functional entity]” adjacent to and following each data item. The data reported shall be as identified by the bus number, name, and/or identifier that is assigned in conjunction with the PC, TO, or TP.

steady-state <i>(Items marked with an asterisk indicate data that vary with system operating state or conditions. Those items may have different data provided for different modeling scenarios)</i>	dynamics <i>(If a user-written model(s) is submitted in place of a generic or library model, it must include the characteristics of the model, including block diagrams, values and names for all model parameters, and a list of all state variables)</i>	short circuit
<ol style="list-style-type: none"> 1. Each bus [TO] <ol style="list-style-type: none"> a. nominal voltage b. area, zone and owner 2. Aggregate Demand¹³ [LSE] <ol style="list-style-type: none"> a. real and reactive power* b. in-service status* 3. Generating Units¹⁴ [GO, RP (for future planned resources only)] <ol style="list-style-type: none"> a. real power capabilities - gross maximum and minimum values b. reactive power capabilities - maximum and minimum values at real power capabilities in 3a above c. station service auxiliary load for normal plant configuration (provide data in the same 	<ol style="list-style-type: none"> 1. Generator [GO, RP (for future planned resources only)] 2. Excitation System [GO, RP (for future planned resources only)] 3. Governor [GO, RP (for future planned resources only)] 4. Power System Stabilizer [GO, RP (for future planned resources only)] 5. Demand [LSE] 6. Wind Turbine Data [GO] 7. Photovoltaic systems [GO] 8. Static Var Systems and FACTS [GO, TO, LSE] 9. DC system models [TO] 10. Other information requested by the Planning Coordinator or Transmission Planner 	<ol style="list-style-type: none"> 1. Provide for all applicable elements in column “steady-state” [GO, RP, TO] <ol style="list-style-type: none"> a. Positive Sequence Data b. Negative Sequence Data c. Zero Sequence Data 2. Mutual Line Impedance Data [TO] 3. Other information requested by the Planning Coordinator or Transmission Planner necessary for modeling purposes. [BA, GO, LSE, TO, TSP]

¹³ For purposes of this attachment, the functional entity references are represented by abbreviations as follows: Balancing Authority (BA), Generator Owner (GO), Load Serving Entity (LSE), Planning

Coordinator (PC), Resource Planner (RP), Transmission Owner (TO), Transmission Planner (TP), and Transmission Service Provider (TSP).

² For purposes of this item, aggregate Demand is the Demand aggregated at each bus under item 1 that is identified by a Transmission Owner as a load serving bus. An LSE is responsible for providing this information, generally through coordination with the Transmission Owner.

³ Including synchronous condensers and pumped storage.

<p>manner as that required for aggregate Demand under item 2, above).</p> <ul style="list-style-type: none"> d. regulated bus* and voltage set point* (as typically provided by the TOP) e. machine MVA base f. generator step up transformer data (provide same data as that required for transformer under item 6, below) g. generator type (hydro, wind, fossil, solar, nuclear, etc) h. in-service status* <p>4. AC Transmission Line or Circuit [TO]</p> <ul style="list-style-type: none"> a. impedance parameters (positive sequence) b. susceptance (line charging) c. ratings (normal and emergency)* d. in-service status* <p>5. DC Transmission systems [TO]</p> <p>6. Transformer (voltage and phase-shifting) [TO]</p> <ul style="list-style-type: none"> a. nominal voltages of windings b. impedance(s) c. tap ratios (voltage or phase angle)* d. minimum and maximum tap position limits e. number of tap positions (for both the ULTC and NLTC) f. regulated bus (for voltage regulating transformers)* g. ratings (normal and emergency)* h. in-service status* 	<p>necessary for modeling purposes. [BA, GO, LSE, TO, TSP]</p>	
---	--	--

<p>7. Reactive compensation (shunt capacitors and reactors) [TO]</p> <ul style="list-style-type: none">a. admittances (MVars) of each capacitor and reactorb. regulated voltage band limits* (if mode of operation not fixed)c. mode of operation (fixed, discrete, continuous, etc.)d. regulated bus* (if mode of operation not fixed)e. in-service status* <p>8. Static Var Systems [TO]</p> <ul style="list-style-type: none">a. reactive limitsb. voltage set point*c. fixed/switched shunt, if applicabled. in-service status* <p>9. Other information requested by the Planning Coordinator or Transmission Planner necessary for modeling purposes. [BA, GO, LSE, TO, TSP]</p>		
--	--	--

SECTION: APPENDIX VII

Modeling of Generator Parameters

1. Applicable Facilities - The following Generators and SVCs connected to BES (100 kV and greater) or in accordance with the SPP OATT or Member OATT.
 - a. All Individual units greater than 20 MVA (gross nameplate rating)
 - b. All Synchronous Condensers greater than 20 MVA (gross nameplate rating)
 - c. Generating plant/facilities greater than 75 MVA (gross aggregate nameplate rating)

Modeling Process for Generator Parameters

- a. The Generator parameter P_{MAX} shall be modeled as a gross seasonal maximum capability based on MOD-025-02 and SPP Planning Criteria 7.1 testing and reporting procedures.
- b. Generating plant station service and auxiliary loads shall be represented in normal plant configuration, corresponding to the load appropriate to operation of the generating plant. All station service and auxiliary load representations shall:
 - i. Be modeled explicitly on the appropriate bus15, corresponding to the voltage to which the auxiliary load is served. Model representations of auxiliary load connected to the generating unit bus (Figure VII-1), auxiliary load modeled with separate transformation (Figure VII-2), and auxiliary load modeled on the high-side bus of the station service transformer (Figure VII-3) are acceptable.
 - ii. Be annotated as non-scalable.

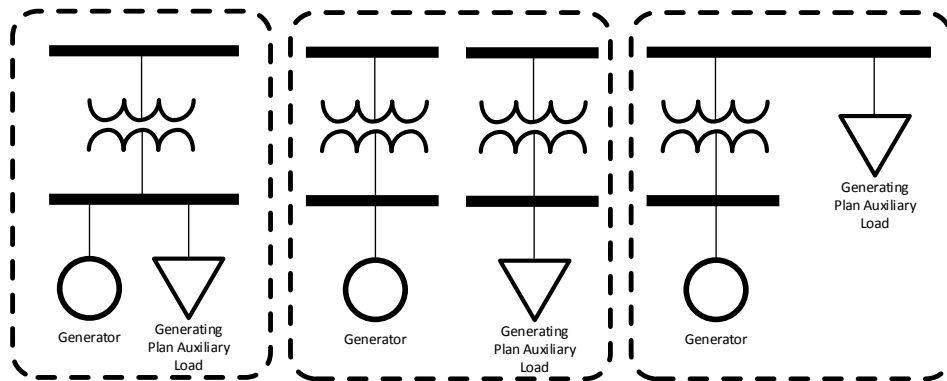

Figure VII-1. Common bus representation

FigureVII-2. Separate transformation representation

FigureVII-3. Transformer high-side representation

15 Station service and auxiliary load shall not be netted against generating plant dispatch by reducing the P_{gen} of a unit with an amount corresponding to the plant auxiliary load.

- c. Experience has shown that generating plant station service and auxiliary load may vary considerably based upon generating plant dispatch and operating conditions. Therefore, generating plant station service and auxiliary load may be modeled as aggregated or non-aggregated generating plant load, representing the total quantity of fixed and variable station service and auxiliary load.

If generating plant station service and auxiliary load is **aggregated**, the total load quantity shall properly reflect the total real and reactive loading for the generating units. The aggregated generating plant station service and auxiliary load shall use "SS" in the Load ID field (Figure VII-4a). If there are more than one aggregated generating plant station service and auxiliary load, use "Sn" in the Load ID field to delineate the multiple aggregated loads.

If generating plant station service and auxiliary load is **not aggregated**, each load quantity shall properly reflect the real and reactive loading expected during the corresponding dispatch (e.g., generating plant Pgen may be less than Pmax) and operating conditions for the generating units. Combined loads are analogous to aggregating generating plant station service and auxiliary load, with additional detail specifying the fixed and variable portions of total generating plant load (Figure VII-4b). The combined or discrete (Figure VII-4b and Figure VII-4c) load representations shall:

- i. Use "Fn" in the Load ID field¹⁶ to designate fixed load quantities that do not vary with plant dispatch.
- ii. Use "Vn" in the Load ID field⁴ to designate variable load quantities that do vary with plant dispatch.

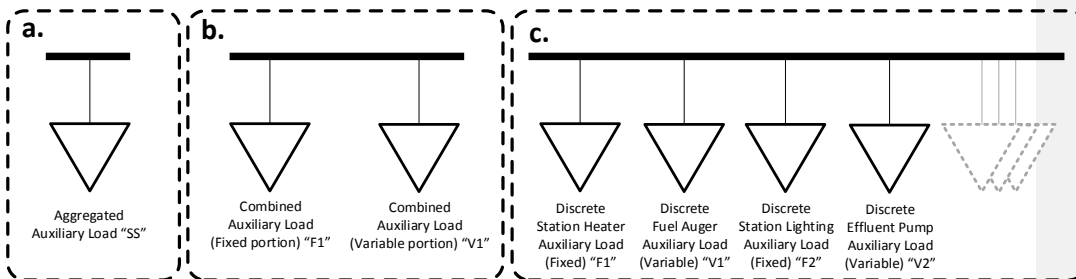

Figure VII-4. Examples of generating plant auxiliary load representations (aggregated, combined, and discrete).

- d. The Generator Parameters for PMIN, AUX Load, QMAX, and QMIN shall be modeled in accordance with MOD-025-02 and SPP Planning Criteria 7.1 testing and reporting procedures.

¹⁶ "n" represents a unique numeric value. PSS/E requires each load placed at a bus to have a unique Load ID.

Modeling of Wind/Solar Renewable Resources P_{GEN}

- Light load models: Output of renewable resources with long-term firm transmission service will be modeled in the light load model at each facility's latest five-year average (or replacement data if unavailable) for the SPP coincident off-peak hour corresponding to the season of the Light Load case, not to exceed each facility's firm service amount. Solar resources will be modeled at zero MW output in the light load case regardless of the facility's long-term firm transmission service amount.
- Peak models: Output of renewable resources with long-term firm transmission service will be modeled in the case(s) at each facility's latest five-year average (or replacement data if unavailable) for the applicable seasonal SPP coincident¹⁷ peak, not to exceed each facility's firm service amount.
- To the maximum extent possible, historical data will be used to determine the renewable dispatch. The following table will be used for default renewable dispatch percentage in lieu of resources that do not have five years of historical data.

States	Winter %	Spring %	Light Load %	Summer %	Fall %
Iowa	66.2%	26.1%	26.5%	39.5%	35.9%
South Dakota	50.7%	8.2%	44.6%	17.5%	29.7%
Oklahoma	30.5%	45.7%	46.3%	35.1%	53.6%
Kansas	37.9%	29.3%	25.3%	36.6%	50.3%
Texas	41.0%	45.1%	53.0%	37.3%	61.5%
North Dakota	51.8%	26.2%	10.9%	21.3%	9.1%
New Mexico	40.7%	55.0%	44.0%	30.3%	53.2%
Nebraska	51.6%	16.1%	20.1%	6.2%	40.2%
Missouri	59.5%	34.8%	28.9%	7.6%	39.1%

Default Renewable Firm Service Dispatch in lieu of Historical Data.¹⁸

- SPP will make available the initial dispatch of renewable resources with long-term firm transmission service based on historical seasonal five-year average with the initial model pass of the each SPP MDWG model build.
- When an affected party disagrees with the dispatch amount for a facility, the affected parties involved should coordinate to update the dispatch amount. If agreement cannot be reached, the case can be brought to the MDWG for a decision.
- Responsibility for validating and providing renewable resource dispatch updates falls to the affected parties.
 - For resources that do not have firm service, P_{GEN} values should not exceed average historical seasonal values for the Light Load, Spring, Summer, Summer Shoulder, Fall, and Winter Cases. If historical data is unavailable then the rated net capability

Formatted: Indent: Left: 0.75", Space After: 0 pt

¹⁷ SPP coincident peak equals the highest demand including transmission losses for energy measured over a one clock hour period during the defined season.

¹⁸ This data is updated annually via the ITP Renewable Resource Replacement Data Methodology process.

[of a resource determined according to SPP Planning Criteria section 7.1.5.3 should be followed. ~~\(for comparable data if historical data is unavailable\).~~](#)

Data Exemption Process

MDWG Members requested that there be a process by which the modeled generator maximum is different from the MOD-025-02/SPP Planning Criteria testing. In accordance with Attachment 1, Section 5 of MOD-025-02 an exception process for generators that have undergone testing per MOD-025-02/SPP Planning Criteria 7.1 for these differences is as follows:

1. Member will fill out the “Exemption Form” and send it via e-mail to “Engineering Modeling” containing:
 - a. Generator Name
 - b. Generator Bus Number
 - c. Requested change(s) that deviate from the MOD-025-02/SPP Planning Criteria testing.
 - d. Justification of the change if it is greater than or less than 5% of the MOD-025-02/SPP Planning Criteria testing.

SPP Modeling will process the Exemption and communicate back to the member requesting the exemption that it has been granted or if additional information is needed to process the exemption within 30 days of submission of the request.

****Effective date of sections 1&3 is in effect.**

****Effective date of section 2 is July 1, 2016.**

****Effective date of section 4 is July 1, 2016.**

SECTION: APPENDIX VIII - BALANCING AND TRANSACTIONS

Background

A core principal of steady-state power flow modeling¹⁹ is the balance between load and generation. A system swing generating unit is a fundamental requirement of the modern formulation of the linear power flow problem (net complex power injection into nodal admittance network). In the balanced three-phase power flow formulation, a swing generator serves the imbalance of power for the entire electrical network. However, in real power systems, Balancing Authorities ensure that frequency regulation is achieved by matching generation to load within a subsection of the entire interconnected power system. Thus, in most power flow software, a vast impedance network may be segregated into groups of busses representing a model area²⁰. While typically analogous to a Balancing Authority Area or control area, the concept of a model area is straightforward: model areas allow the electrical network to be sectioned in such a way as to pool together generation, loads, and losses for the purpose of scheduling power flows throughout the electrical network. Model areas are not limited to being demarcated by physical load balancing boundaries; on the contrary, model areas are very effective at allowing individual generation and load-serving companies to properly allocate resources and demand, including transactions with other model areas. While most power flow software enforces that each generating unit inherits its model area designation from the bus to which it is connected, many modern power flow software packages allow ZIP²¹ loads and induction machine loads to be assigned to model areas that may be different than the busses to which they are connected. In this way, each generating unit and load is grouped into common balancing pools, represented by the model area (Figure 1).

¹⁹ The traditional power flow formulation is the matrix algebraic calculation of voltage phasor (magnitude and angle) at each interstitial connectivity node (bus) within an impedance network under balanced three-phase, steady-state conditions.

²⁰ Model areas typically have a single generator designated as the area slack machine, although this is not a modeling constraint. The area slack machine is analogous to the system swing machine in that it compensates for the power imbalance within the model area, when the power flow solution is solved to respect inter-area transfers (area net interchange control).

²¹ ZIP refers to constant impedance, constant current, or constant power load representations, including a combination of each.

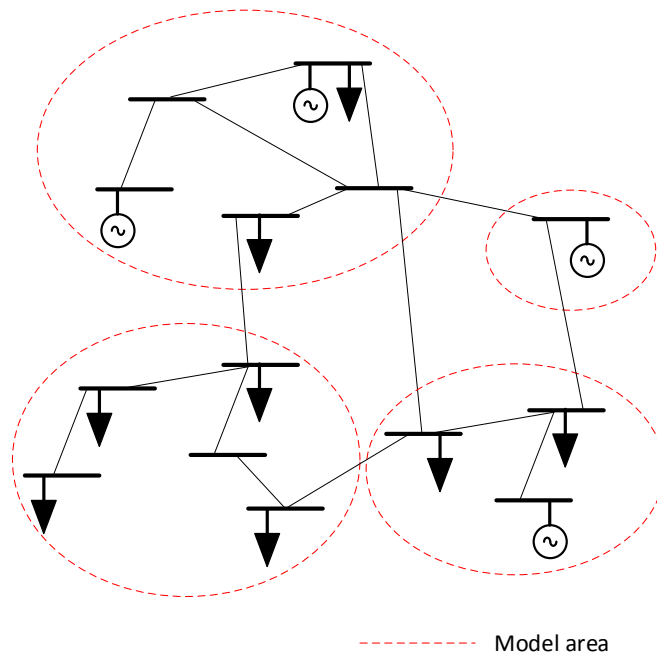

Figure 1. Example of interconnected model areas.

To be clear: it is inappropriate to refer to either a “generation area” or a “load area”. Instead, it is important to understand that the modeling concept of the “Area” field designated for bus, load, and generation refers to the model area to which that model object belongs. To reiterate, the model area to which a load is assigned indicates which generation resources will serve that load, independent of the model area of the bus to which that load is attached. This concept is of particular importance when interchange is used to obtain power flow solutions.

Within each model area that contains generating units, a single generating unit must be designated as the slack machine. While the dispatch (Pgen) of each non-slack generating unit is set to a prescribed value, the slack machine dispatch varies to compensate for any imbalance within the model area. In many cases, load obligations and transmission losses associated with delivering power to the loads within a model area may not be totally served by the capacity of resources in-service within a model area. In these situations, inter-area transfers are common, representing power purchase agreements (PPA) that reflect the firm purchase or sale of power from generation resource in one model area to another for the purpose of serving load. Similarly, intra-area transfers representing contractual or PPA obligations between resource and load owners within a model area are also common. In total, all inter- and intra-area transfers are referred to as “transactions” and must be properly accounted for to achieve power flow model balancing and accurate model area tie-line loading.

Across the entire interconnected impedance network, one-and-only-one generating unit must be designated as the system swing unit. The system swing serves any overall imbalance arising from

imbalanced exchanges between individual model areas. In its simplest expression, the model area designation facilitates the analysis of scheduled power flow between interconnected regions of the impedance network, which is useful for assessing conventional tie-line loading. More broadly, however, the use of model areas allows exchanges of generating resources that are intended to serve loads that may be very distant from the actual generating unit, giving rise to bilateral transactions across model area boundaries, integrated market operations, and efficient resource dispatch, as well as others.

Load is generally served by generation resources within a common model area. Likewise, both the load and the bus to which the load is connected reflect a common model area (as shown in the Area field of each). The same principle applies to transacted resource-to-load; loads that serve as the sink portion of a transacted real power quantity will reside in the model area of the sink Data Owner (and may retain the load ID of the Data Owner of the load itself). Exceptions are called pseudo-ties, representing where the resource that serves the load is outside of the model area where the load resides. Pseudo-tied loads are typically found when the Area field assigned to the load is different than the Area field of the bus, to which the load is connected, however generation pseudo-ties are possible, as well. For modeling purposes, pseudo-tie representations are permitted between two model areas within the SPP Balancing Authority (referred to an intra-SPP pseudo-tie), as well as between a model area within the SPP Balancing Authority and a model area of a non-SPP Balancing Authority (referred to an inter-SPP pseudo-tie). Intra-SPP pseudo-ties can be an effective means of differentiating which model area provides resource to unique load delivery obligations, but may be problematic if used to avoid proper resource, load, and loss accounting through model area transactions. Separately, inter-SPP pseudo-tie arrangements are typically unique contractual arrangements where firm transmission service (e.g., network services, point-to-point) has been pre-arranged to direct resource from/to an external model area, into/out of a model area where the load resides (see Figure 2). Inter-SPP pseudo-tied loads are generally an exception to the norm and the use of inter-SPP pseudo-tied loads should be justified (e.g., reference to an SPP load-balancing meter point, pseudo-tie registration in the SPP marketplace, etc.). Data Owners shall not create pseudo-tie modeling representations of load that incorporates fictitious topology; Data Owners may create pseudo-tie modeling representations of generation necessary, given the load flow software constraints.

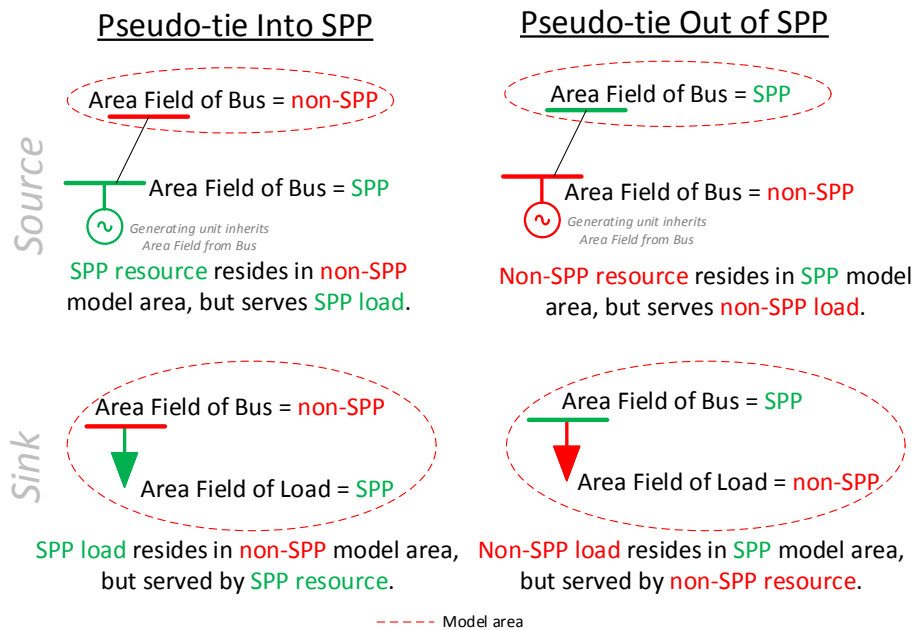

Figure 2. Four types of inter-SPP pseudo-ties.

Transactions Data Requirements

Data Owners shall submit all transactions data via the ~~MDWG Data Submittal Workbook~~EDST. Additionally, Data Owners shall:

1. Coordinate all bilateral transactions data with all Data Owners who are party to the transaction, prior to submitting the data.
2. Submit only the bilateral portion of the transaction for which the Data Owner is responsible. For example, in a bilateral transaction between two Data Owners (SPP-members), each Data Owner shall submit one half of the transaction (source or sink). In the case of a bilateral transaction between a Data Owner (SPP-member) and a non-SPP member, such as a MISO-member, the Data Owner (SPP-member) shall submit their portion (source or sink) of the bilateral transaction, upon coordination with the non-SPP member. SPP staff will then submit the non-SPP member portion (source or sink) of the bilateral transaction.
3. Review and update transactions data according to the model building schedule.
4. Load and resource transactions may be inter-area (i.e., reciprocal transaction from an SPP Market Participant to another SPP Market Participant, both within the SPP Balancing Authority Area) or external area (i.e. traditional BA-to-BA interchange). Transactional data collected by Data Owners often have tens of kilowatts precision. However, for the purposes of the ERO, or its designee, Interconnection-wide models,

external net interchange schedules are required to be entered as whole MW quantities. Therefore, Data Owners shall submit transaction data according to:

- a. Inter-area transactions (transactions of load and resource that are wholly contained within the SPP Balancing Authority Area) are preferred to be integer values (i.e. whole MW); however, shall not exceed tens of kilowatt precision (i.e., two decimal MW precision; 0.01MW).
 - b. External area transaction (i.e. scheduled net interchange between the SPP Balancing Authority and an external Balancing Authority) shall be rounded to the nearest integer (i.e. whole MW).
5. Ensure that source transactions have positive polarity, while sink transactions have negative polarity (Figure 3 and Figure 4).

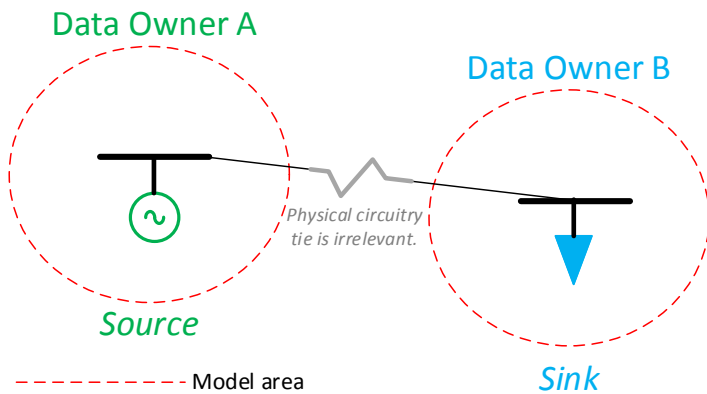

Inter-area Bilateral transaction description

Data Owner A exports MW to Data Owner B

Data Owner B imports MW from Data Owner A

Transaction accounting in Data Submittal Workbook

PC	From Area #	From Area	From Resp Entity #	From Resp Entity Name	To Area #	To Area	To Resp Entity #	To Resp Entity Name	ID	Start	Stop	Firm	201x Series MDWG Model - 18G
SPP	1	Area 1	1	Data Owner A	2	Area 2	2	Data Owner B	ABC111	12/1/2013	3/1/2020	X	MW
Not SPP	2	Area 2	2	Data Owner B	1	Area 1	1	Data Owner A	ABC111	12/1/2013	3/1/2020	X	-MW

Figure 3. Example of Inter-area transfer (transaction).

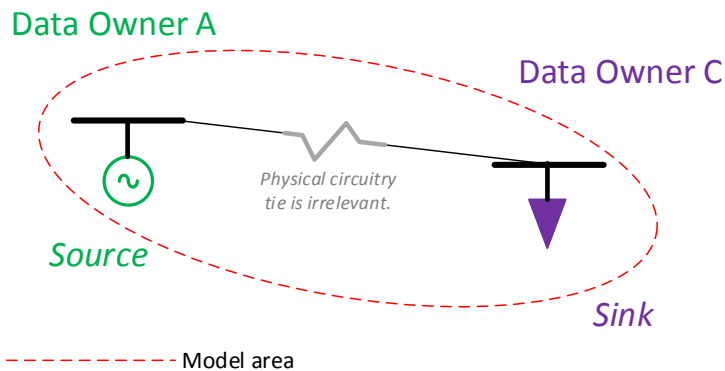

Intra-area Bilateral transaction description

Data Owner A exports MW to Data Owner C

Data Owner C imports MW from Data Owner A

Transaction accounting in Data Submittal Workbook

PC	From Area #	From Area	From Resp Entity #	From Resp Entity Name	To Area #	To Area	To Resp Entity #	To Resp Entity Name	ID	Start	Stop	Firm	201x Series MDWG Model - 18G
SPP	1	Area 1	1	Data Owner A	1	Area 1	1	Data Owner C	XYZ112	12/1/2013	3/1/2020	X	MW
SPP	1	Area 1	1	Data Owner C	1	Area 1	1	Data Owner A	XYZ112	12/1/2013	3/1/2020	X	-MW

Figure 4. Example of Intra-area transfer (transaction).

6. Complete the following required ~~Data Submittal Workbook~~EDST data fields for each source and sink portion of a bilateral transaction:
 - a. Planning Coordinator (PC).
 - b. From Area #.
 - c. From Area Name.
 - d. From Responsible Entity #.
 - e. From Responsible Entity Name.
 - f. To Area #.
 - g. To Area Name.
 - h. To Responsible Entity #.
 - i. To Responsible Entity Name.
 - j. Transaction ID.
 - k. Transaction Start date.
 - l. Transaction Stop date.
 - m. Firm or Non-Firm Transaction.
 - n. Transaction quantity (in MW) for all appropriate seasonal MDWG Model Series cases.

7. When a part or all of a bilateral transaction is referenced by an Open Access Same-Time Information System (OASIS) number, used by the marketer for scheduling, enter the OASIS number in the appropriate [Data Submittal Workbook](#) [EDST](#) field.
8. The following [Data Submittal Workbook](#) [EDST](#) information is reserved for SPP staff usage and is not required from the Data Owner of each bilateral transaction:
 - a. From Attributes.
 - b. To Attributes.
 - c. Link Number.
 - d. Plant.
 - e. Capacity.
 - f. Roll Over Rights.
 - g. S0 Scalable.
 - h. S5 Scalable.
 - i. OASIS Comment.
 - j. Comments.
 - k. Related Reference.